



HOME-THEATER TELEVISION

MODELS

638 Series

C10 Series

OWNER'S GUIDE

- For questions:
 - Visit our website at www.mitsubishi-tv.com.
 - E-mail us at MDEAservice@mdea.com.
 - Call Consumer Relations at 800-332-2119 for operational or connection assistance.
- For information on **System Reset**, please see the back cover.
- To order replacement or additional remote controls or lamp cartridges, visit our website at www.mitsuparts.com or call 800-553-7278.

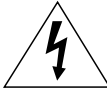

	CAUTION RISK OF ELECTRIC SHOCK DO NOT OPEN	
CAUTION: TO REDUCE THE RISK OF ELECTRIC SHOCK, DO NOT REMOVE COVER (OR BACK). NO USER SERVICEABLE PARTS INSIDE. REFER SERVICING TO QUALIFIED SERVICE PERSONNEL.		

 The lightning flash with arrowhead symbol within an equilateral triangle is intended to alert the user of the presence of uninsulated "dangerous voltage" within the product's enclosure that may be of sufficient magnitude to constitute a risk of electric shock to persons.

 The exclamation point within an equilateral triangle is intended to alert the user to the presence of important operating and maintenance (servicing) instructions in the literature accompanying the product.

MAINS DISCONNECTION: The mains plug is used as the disconnect device. The mains plug shall remain readily operable.

Stand Requirement

CAUTION: Use these Mitsubishi TV models only with the Mitsubishi stand models shown here. Other stands can result in instability and possibly cause injury.

TV Model	Stand Model
WD-60638, WD-65638 WD-60C10, WD-65C10	MB-S60/65A
WD-73638 WD-73C10	MB-S73A

TV WEIGHT: This TV is heavy. Exercise extreme care when lifting or moving it. Lift or move the TV with a minimum of two adults. To prevent damage to the TV, avoid jarring or moving it while it is turned on. Always power off your TV, unplug the power cord, and disconnect all cables before moving it.

WARNING: To reduce the risk of fire or electric shock, do not expose this apparatus to rain or moisture.

This apparatus shall not be exposed to dripping or splashing and no objects filled with liquids, such as vases, shall be placed on the apparatus.

WARNING: This product contains chemicals known to the State of California to cause cancer and/or birth defects or other reproductive harm.

Note: Features and specifications described in this owner's guide are subject to change without notice.

FCC Declaration of Conformity

Product: Projection Television Receiver
 Models: WD-60638, WD-65638, WD-73638
 WD-60C10, WD-65C10, WD-73C10
 Responsible Party: Mitsubishi Digital Electronics
 America, Inc.
 9351 Jeronimo Road
 Irvine, CA 92618-1904
 Telephone: (800) 332-2119

This device complies with Part 15 of the FCC Rules. Operation is subject to the following two conditions:

- (1) This device may not cause harmful interference, and
- (2) This device must accept any interference received, including interference that may cause undesired operation.

Note: This equipment has been tested and found to comply with the limits for a Class B digital device, pursuant to part 15 of the FCC Rules. These limits are designed to provide reasonable protection against harmful interference in a residential installation. This equipment generates, uses and can radiate radio frequency energy and, if not installed and used in accordance with the instructions, may cause harmful interference to radio communications. However, there is no guarantee that interference will not occur in a particular installation. If this equipment does cause harmful interference to radio or television reception, which can be determined by turning the equipment off and on, the user is encouraged to try to correct the interference by one or more of the following measures:

- Reorient or relocate the receiving antenna.
- Increase the separation between the equipment and the receiver.
- Connect the equipment into an outlet on a circuit different from that to which the receiver is connected.
- Consult the dealer or an experienced radio/TV technician for help.

Changes or modifications not expressly approved by Mitsubishi could cause harmful interference and would void the user's authority to operate this equipment.

Contents

1 Setup and Operation

Getting Started	5
TV Controls	6
The STATUS Indicator	7
TV Inputs	8
Picture Settings	8
Using an External Sound System	8
The FORMAT Key and Picture Shape	9
FAV (Favorite Channels)	10
Using the TV with a Personal Computer	11
Status Display	12
3D Video	13

2 TV Connections

Connection Panel	15
Connection Types and Audio/Video Quality	16
HDMI Device	17
DVI Video Device	17
Y Pb Pr Component Video Device	17
Composite Video Device	17
Antenna or Cable TV Service	18
VCR or DVD Recorder to an Antenna or Wall Outlet Cable	18
A/V Receiver with Coaxial Input	18
A/V Receiver with HDMI Output	19

3 TV Menus

Picture	20
Sound	21
Setup	21
Channels	23
Locks	24

Appendices

Appendix A: TV Care	
Lamp-Cartridge Replacement	27
Cleaning Recommendations	29
Care of the Remote Control	29
Appendix B: Troubleshooting	30

Trademark and License Information	33
----------------------------------------------------	----

Warranty	38
---------------------------	----

For Your Records

Record the model number, serial number, and purchase date of your TV. The model and serial numbers are on the back of the TV. Refer to this page when requesting assistance with the TV.

MODEL NUMBER _____
SERIAL NUMBER _____
PURCHASE DATE _____
RETAILER NAME _____
LOCATION _____

Custom cabinet installation must allow for proper air circulation around the television.

NOTE TO CATV SYSTEM INSTALLER: THIS REMINDER IS PROVIDED TO CALL THE CATV SYSTEM INSTALLER'S ATTENTION TO ARTICLE 820-40 OF THE NEC THAT PROVIDES GUIDELINES FOR THE PROPER GROUNDING AND, IN PARTICULAR, SPECIFIES THAT THE CABLE GROUND SHALL BE CONNECTED TO THE GROUNDING SYSTEM OF THE BUILDING, AS CLOSE TO THE POINT OF CABLE ENTRY AS PRACTICAL.

Internal Fans

Internal cooling fans maintain proper operating temperatures inside the TV. It is normal to hear the fans when you first turn on the TV, during quiet scenes while viewing the TV, and for a short time after shutting off the TV. You may notice louder fan noise about 30 seconds after shutting off the TV.

Lamp Replacement

For lamp-replacement instructions, see Appendix A.

To Order a Replacement Lamp Under Warranty

Call (800) 553-7278. Please have model number, serial number, and TV purchase date available.

Important: All lamps replaced under warranty must be returned to Mitsubishi where they will be inspected to verify failure defects.

To Purchase a Replacement Lamp After Warranty

Visit our website at www.mitsuparts.com or call (800) 553-7278. Order new lamp part number 915B441001.

TV Software

Do not attempt to update the software of this TV with software or USB drives not provided by or authorized by Mitsubishi Digital Electronics America, Inc. Non-authorized software may damage the TV and will not be covered by the warranty.

Children and TV Viewing

The American Academy of Pediatrics discourages television viewing for children younger than two years of age.

Important Safety Instructions

Please read the following safeguards for your TV and retain for future reference. Always follow all warnings and instructions marked on the television.

- 1) Read these instructions.
- 2) Keep these instructions.
- 3) Heed all warnings.
- 4) Follow all instructions.
- 5) Do not use this apparatus near water.
- 6) Clean only with dry cloth.
- 7) Do not block any ventilation openings. Install in accordance with the manufacturer's instructions.
- 8) Do not install near any heat sources such as radiators, heat registers, stoves, or other apparatus (including amplifiers) that produce heat.
- 9) Do not defeat the safety purpose of the polarized or grounding-type plug. A polarized plug has two blades with one wider than the other. A grounding type plug has two blades and a third grounding prong. The wide blade or the third prong are provided for your safety. If the provided plug does not fit into your outlet, consult an electrician for replacement of the obsolete outlet.
- 10) Protect the power cord from being walked on or pinched particularly at plugs, convenience receptacles, and the point where they exit from the apparatus.
- 11) Only use attachments/accessories specified by the manufacturer.
- 12) Use only with the cart, stand, tripod, bracket, or table specified by the manufacturer, or sold with the apparatus. When a cart is used, use caution when moving the cart/apparatus combination to avoid injury from tip-over.
- 13) Unplug this apparatus during lightning storms or when unused for long periods of time.
- 14) Refer all servicing to qualified service personnel. Servicing is required when the apparatus has been damaged in any way, such as power-supply cord or plug is damaged, liquid has been spilled or objects have fallen into the apparatus, the apparatus has been exposed to rain or moisture, does not operate normally, or has been dropped.



EXAMPLE OF ANTENNA GROUNDING

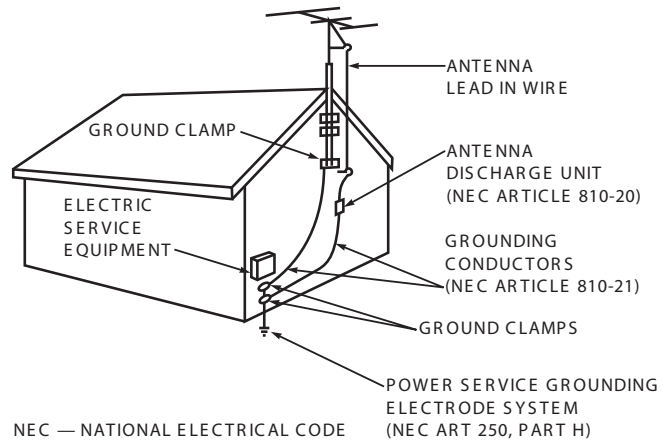

Outdoor Antenna Grounding

If an outside antenna or cable system is connected to the TV, be sure the antenna or cable system is grounded so as to provide some protection against voltage surges and built-up static charges.

Replacement Parts

When replacement parts are required, be sure the service technician has used replacement parts specified by the manufacturer or have the same characteristics as the original part. Unauthorized substitutions may result in fire, electric shock or other hazards.



The following TV models are ENERGY STAR® qualified:
 WD-65638, WD-73638
 WD-65C10, WD-73C10

Products that earn the ENERGY STAR prevent greenhouse gas emissions by meeting strict energy efficiency guidelines set by the U.S. Environmental Protection Agency and the U.S. Department of Energy.





For assistance call 1(800) 332-2119

1 Setup and Operation

Getting Started

Package Contents

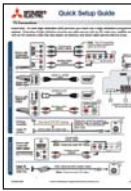
Please take a moment to review the following list of items to ensure that you have received everything.

Remote Control	
Two AA Batteries	
Owner's Guide	
Quick Setup Guide	
Product Registration Card	

Installing the Remote Control Batteries

1. Remove the remote control's back cover by gently pressing on the tab and lifting off the cover.
2. Load the batteries, making sure the polarities (+) and (-) are correct. For best results, insert the negative (-) end first.
3. Snap the cover back in place.

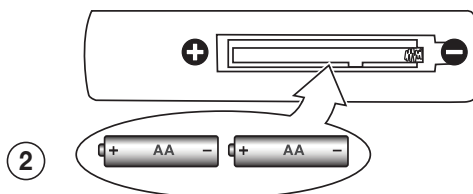
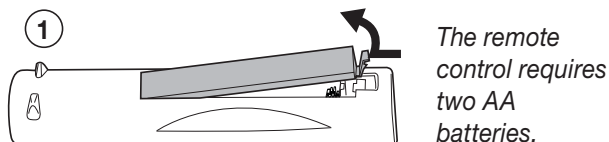

Before You Power on the TV

1. Review the important safety, installation, and operating information at the beginning of this book.
2. Choose a location for your TV.
 - Allow at least four inches of space on all sides of the TV to help prevent overheating. Overheating may cause premature failure of the TV as well as shortened lamp life.
 - Avoid locations where light may reflect off the screen.
 - See the stand requirements on page 2.
3. Install the batteries in the remote control.
4. Plug the TV into an AC power outlet.

First-Time Power-On

1. **Connect your devices to the TV.**
 - See page 15 for suggestions.
 - If using an antenna or direct cable service (no cable box), connect the incoming coaxial cable to the TV's **ANT** input. Refer to page 18.
 - Make note of which device is connected to each TV input.
2. **Power on the TV.**
Aim the emitter end of the remote at the TV and press **POWER**.
3. **Follow the on-screen instructions for basic setup:**
 - a. Select a menu language.
 - b. Select your time zone.
 - c. Select **Yes** or **No** for Daylight Saving Time.
 - d. Select the source connected to the TV's **ANT** input jack, either an over-the-air antenna or direct cable service without a box. Skip this step if nothing is connected.
 - e. Perform a channel scan for channels available from the **ANT** input.
 - f. Wait a few moments for the screen to clear.

TV Controls

Remote Control

Sleep Timer. Turns off the TV after the length of time you set. Press **SLEEP** repeatedly to increase the time from 15 minutes up to the maximum of 90 minutes. To cancel the timer, press **SLEEP** again to highlight **Off**.

Number/letter keys

Channel tuning, page 8
PIN entry, page 24

CANCEL Adds a separator in digital channel numbers. Clears some menu entries.

MUTE Mutes the TV speakers.

VOL \wedge/\vee Controls volume of TV speakers.

CH \wedge/\vee Changes channels

$\blacktriangle\blacktriangledown\blacktriangleleft\blacktriangleright$ Navigation and adjustment controls

ENTER Press to confirm a selection.

INFO TV status, page 12

Note

The following keys are not used in this model:

TOOLS **GUIDE**

If You Power Off the TV by Mistake

If the status indicator is green and blinking rapidly, (about 60 seconds after you shut off power), wait a few moments for the status indicator to stop blinking and press **POWER** to turn the TV on again.

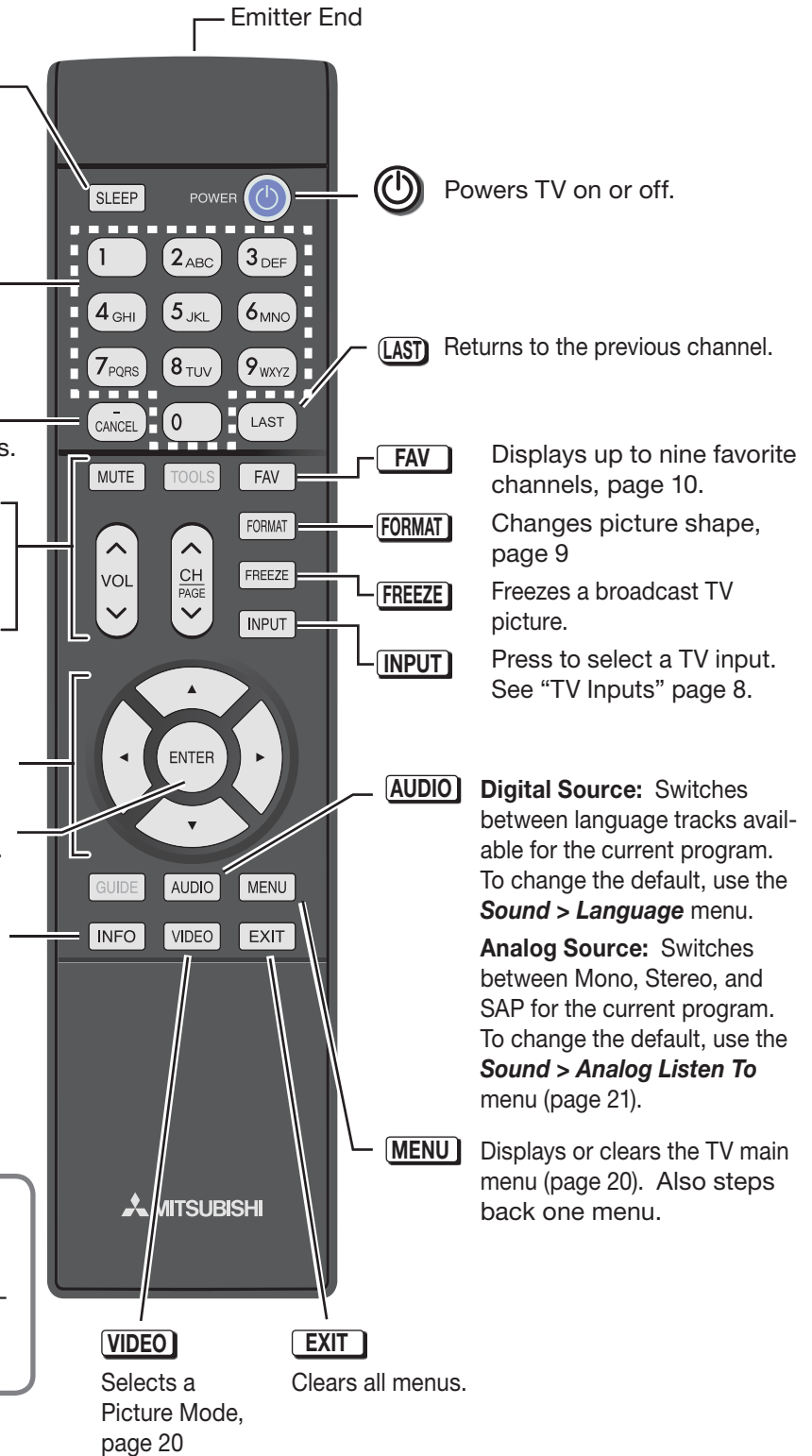

TV Controls, continued

TV Control Panel

Buttons on the control panel duplicate some keys on the remote control.

- Refer to **lower labels** when using TV menus or after activating a special function.
- Refer to **upper labels** when no TV menus are displayed.
- **SYSTEM RESET.** If the TV does not respond to the remote control, control-panel buttons, or will not power on/off, press and hold the **POWER** button on the control panel for ten seconds.

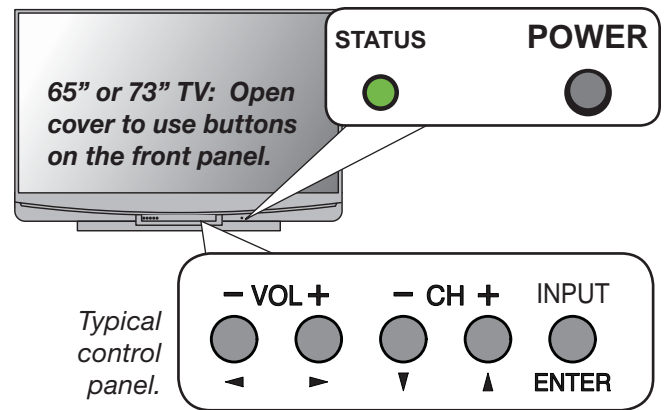

The STATUS Indicator

Key		Off		Steady On
		Slow Blinking		Fast Blinking

LED Color	TV Condition
None	TV is powered off. Normal operation.
Green	TV is powered on. Normal operation.
Green	TV powered off, auto-on TV Timer is set. Normal operation. TV can be turned on at any time.
Green	TV just powered off and lamp is cooling. Sixty seconds after turning off TV, LED will start to blink. TV can be turned back on before blinking starts or after blinking stops, but not while the indicator is blinking. Normal operation.
Amber	TV is too hot. The TV will shut off if it overheats. <ul style="list-style-type: none"> • Ambient room temperature may be too high. Turn off the TV and let the room temperature drop. • Clear blocked air vents. Ensure at least a four-inch clearance on all sides of the TV.
Amber	Lamp access door is not secure or no lamp installed. TV will not operate until lamp access door is secured. See Appendix A.
Red	Lamp failure. Replace the lamp. See Appendix A.
Red/ Amber	TV may require service. <ul style="list-style-type: none"> • Hold power button on front panel for 10 seconds to reset TV. • If LED continues to flash red and amber after reset, turn off the TV and unplug it from the AC power source. Wait one minute and then plug the set back in. • If LED continues to flash red and amber, go to www.mitsubishi-tv.com or call 1-800-332-2119 to receive Authorized Service Center information. <p>You may be asked to count how many times the LED flashes each color to aid in troubleshooting.</p>

TV Inputs

Selecting an Input to Watch

Press the **INPUT** key to select a TV input to watch. Use the **Setup > Input** menu to rename, add, or remove inputs from the list.

Naming

Assign helpful names to TV inputs.

1. Press **MENU**.
2. Go to the **Setup > Input > Input Name** menu.
3. In the inputs list, highlight the input to change and press **ENTER**.
4. Highlight a name in the name list.

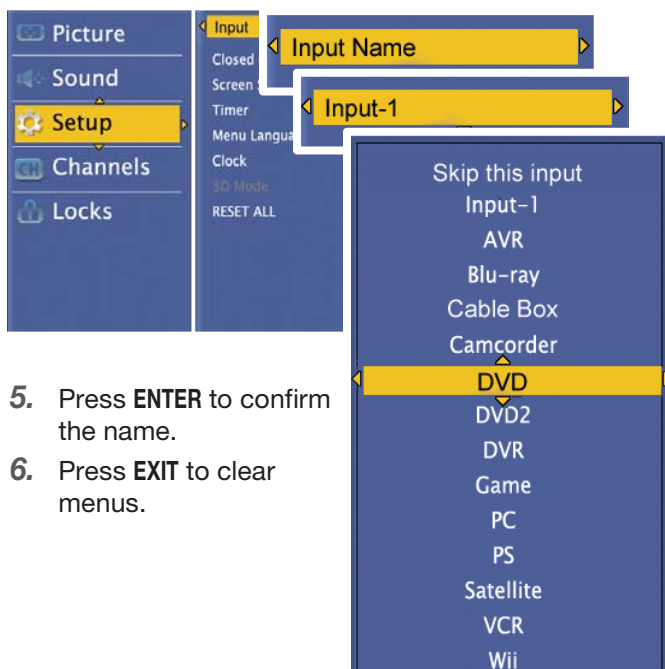

5. Press **ENTER** to confirm the name.
6. Press **EXIT** to clear menus.

Removing

To remove unused inputs from the input list,

1. Switch to an input other than the one you are removing.
2. Go to the name list for the input as described above.
3. Highlight **Skip this input** and press **ENTER**.
4. Press **EXIT** to clear menus.

Tuning Channels from the Antenna Input

After performing a channel scan, use these methods to tune to channels on the **ANT** input. Channels can be either from an over-the-air antenna or from direct cable service.

- Enter the channel number using the number keys on the remote control and press **ENTER**.
- Include the sub-channel when tuning digital channels. For a two-part digital channel, such as 3-1, press **3** **CANCEL** **1** **ENTER**.
- Press **CH** **^**/**v** to change channels one channel at a time.
- Press and hold **CH** **^**/**v** to speed through channels.
- Press **LAST** to return to the previous channel.
- Use the Fav (Favorites) feature to tune to up to nine favorite channels. See page 10.

Picture Settings

1. To get the best picture under different viewing conditions, set the Picture Mode first before changing other video settings. See page 20.

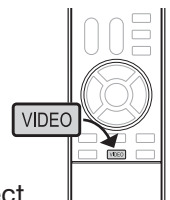

- a. Press **VIDEO** multiple times to select one of these Picture Modes:

Name	When to Use
Brilliant	Under bright light
Bright	For most daytime viewing
Natural	For most nighttime viewing
Game	With gaming consoles

- b. Press **ENTER** to confirm your selection.

2. Wait a few seconds for the display to clear.

Additional picture options are available in the **Picture** menu, page 20.

Using an External Sound System

To switch from the internal TV speakers to an external sound system:

1. Press **MENU**.
2. Display the **Sound > TV Speaker** option.
3. Press **ENTER** to switch between **ON** and **OFF**.

Additional audio controls are in the **Sound** menu, page 21.

The FORMAT Key and Picture Shape

Using the FORMAT Key

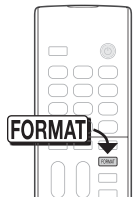

Repeatedly press the **FORMAT** key to cycle through displays available for the current program. The TV will remember the format you last used on each input.

Important

Black bars at the edges of the picture are common in HD pictures. Black bars are not a defect of the TV.

- Black bars are added by broadcasters to fill the 16:9 screen area while preserving the original aspect ratio of the picture.
- Your cable box, satellite receiver, or DVD player may also be altering the broadcast picture. If your device offers output in native format, try using it with Mitsubishi's picture formats.

Sample Uses of the FORMAT Key

You can use the **FORMAT** key to reduce or eliminate black areas at the picture edges.



Squarish 4:3 image is narrower than the 16:9 screen; unused areas at the sides are filled with black.

Press
FORMAT



Standard mode stretches the picture sideways to fill the screen.



Wide 2.35:1 anamorphic DVD image; unused areas at the top and bottom are filled with black (letterbox effect).

Press
FORMAT



Zoom mode. The picture fills the screen. All four edges are cropped in this mode.

TV Signals and Display Formats

This is a 16:9 widescreen TV suitable for images available from HDTV and many DVDs. You can view older-style, squarish images (4:3 aspect ratio) using one of the display formats described on this page (press the **FORMAT** key to cycle through available display formats).

All high-definition channels send widescreen (16:9) signals, but not all programming was created for the widescreen format. The broadcaster may stretch the image or add side bars to fill the widescreen area.

TV Display Format Definitions

Standard: The full-screen format used by HDTV signals. Use this format to display anamorphic DVDs with a 1.78:1 or 1.85:1 aspect ratio. Anamorphic DVDs with a 2.35:1 aspect ratio are displayed correctly but with top and bottom black bars. Squarish (4:3) images are stretched evenly from side to side. Available for all signals.

Expand: Enlarges the picture to fill the screen by cropping the top and bottom; useful for reducing the

letter box top and bottom bars of non-anamorphic DVD images.

Zoom: Enlarges the picture to fill the screen by cropping the sides, top, and bottom to eliminate black bars.

- **480i/480p and SD 4:3 signals:** Eliminates top and bottom bars on anamorphic DVDs with a 2.35:1 aspect ratio.
- **720p, 1080i, SD 16:9, and HD signals:** Eliminates bars added to squarish 4:3 images.

Stretch: Stretches a squarish 4:3 image across the screen to display the entire image with less distortion than the Standard format.

Narrow: Displays narrow 4:3 images in their original shape. Adds black side bars to fill the screen.

Wide Expand: Enlarges the picture, cropping the image on both sides. Removes or reduces black side bars added to narrow images converted to 16:9 signals for digital broadcast.

TV Signals and Display Formats, continued

Summary of Mitsubishi Display Formats

Original Signal / TV Display	Non-anamorphic or SD 4:3	Anamorphic DVD
Standard	Distorted. Not recommended.	Recommended
Expand	Recommended for letterbox. See Note 1.	Distorted; not recommended. See Note 1.
Zoom	Distorted. Not recommended. See Note 1.	Recommended for anamorphic 2.35:1 images. See Note 1.
Stretch	Recommended for standard broadcasts. See Note 1.	Distorted; not recommended. See Note 1.
Narrow	See Note 1	Distorted; not recommended. See Note 1.

Note 1: Available for 480i, 480p, and digital SD 4:3 signals only.

Original Signal	Display Formats						
SD 16:9 or HD Digital 720p, 1080i, 1080p Signal	<table border="1"> <tr> <td></td> <td>Wide Expand</td> <td>Recommended to remove side bars.</td> </tr> <tr> <td></td> <td>Zoom</td> <td>Recommended to remove bars from the top, bottom, and sides.</td> </tr> </table>		Wide Expand	Recommended to remove side bars.		Zoom	Recommended to remove bars from the top, bottom, and sides.
	Wide Expand	Recommended to remove side bars.					
	Zoom	Recommended to remove bars from the top, bottom, and sides.					

TV Display Formats. Press the **FORMAT** key to see the displays available for the current program.

DVD Image Definitions

Image information may be stated on the DVD case. Some DVDs support both of the formats described below.

Anamorphic (or Enhanced for WideScreen TV)

Indicates DVDs recorded to show widescreen images properly on 16:9 TV sets using the TV's Standard format mode (recommended).

Non-Anamorphic (or 4:3, 1.33:1, Letter Box, or Full Screen)

Indicates DVDs recorded for viewing on squarish TV screens. They may be full screen (4:3 or 1.33:1) which crops movies to fit the narrow TV, or letter box, which adds black top and bottom bars.

FAV (Favorite Channels)

Favorite Channels and the Remote Control

The **FAV** key gives you quick access to favorite channels from the antenna input. You can store up to nine favorite channels.

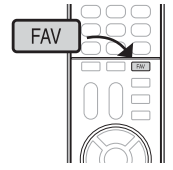

- Adding**
- Switch to the antenna input (press **INPUT** and select Antenna).
 - Tune to the channel.
 - Press the **FAV** key.
 - With the desired channel highlighted, highlight **Add** and press **ENTER**.

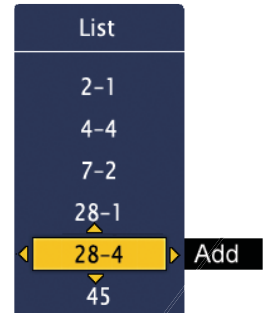

- Removing**
- While using the antenna input, press the **FAV** key.
 - In the **Favorites** menu, highlight the channel to remove.
 - Highlight **Remove** and press **ENTER**.

Method 1

- While watching TV, press the **FAV** key.
- Highlight the channel number in the list and press **ENTER**.

Tuning

Method 2

While watching TV, repeatedly press the **FAV** key to cycle through channels in the FAV list.

The Favorites Menu

- Press **MENU** and go to **Channels > Favorites**.
- Highlight the channel you want to add or remove.

Tip: To jump to a channel, enter the channel number, including separator, and press **ENTER**. Example: **3** **6** **CANCEL** **1** **ENTER**.
- Press **ENTER** to add/remove a check. You can select up to nine favorite channels.

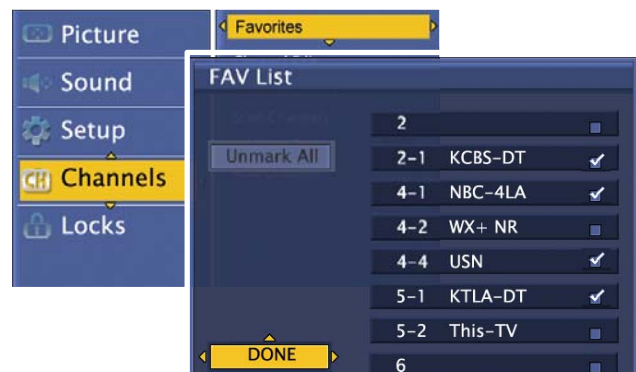

- Highlight **DONE** and press **ENTER** to finish.

Using the TV with a Personal Computer

Connecting a Computer to the TV

Use one of the connection methods listed below based on your computer's video output.

Computer Video Output	Video Connection	Audio Connection
Digital DVI	DVI-to-HDMI cable or an HDMI cable with a DVI-to-HDMI adapter See "DVI Video Device," page 17.	Analog audio cable with mini plugs
HDMI	HDMI-to-HDMI cable See "HDMI Device," page 17.	No additional audio connection is required.

IMPORTANT

This TV accepts digital computer video signals only. This TV is not compatible with VGA (analog) computer video.



1. Connect the computer's digital signal output to one of the TV's HDMI jacks. See the connection diagrams for the method suited to your equipment.
2. Connect the computer's audio output using one of these options:
 - For digital DVI video signals, connect the analog audio output to the TV's **DVI/PC AUDIO INPUT** jack.
 - For HDMI signals, no additional audio connection is required.
 - If your computer provides digital audio output (coaxial or optical), connect it directly to a digital A/V receiver and bypass the TV.

Tip

Set the computer's screen saver to display a screensaver pattern after several minutes of inactivity. This acts as a reminder that the TV is powered on and the lamp is in use. The lamp is in use whenever the TV is powered on, even if the screen appears dark.

3. Power on the TV and computer.
4. Go to the TV's **Setup > Input > Input Name** menu and assign the name **PC**.
5. To switch the TV to the computer, press the **INPUT** key and select PC from the inputs list.

Note: If you are unable to hear audio from the computer, there may be an incompatibility in the computer's hardware, software, or internal settings. Consult a trained computer technician for advice.

Computer Video Adjustments

1. Working from the computer, change the resolution of the computer image. View the computer image on the TV and maximize the computer resolution while maintaining a suitable aspect ratio for the image.
2. Perform TV video adjustments in the **Setup > Picture** menu.
3. Press the **FORMAT** key repeatedly to find the picture format best suited to the image. See the chart on the next page showing how different computer resolutions can be displayed on the TV.

Image Resolution

Your Mitsubishi TV can display the resolutions shown in the chart on the next page from standard VGA (640 x 480) through 1920 x 1080 signals at a refresh rate of 60 Hz.

In most cases, the computer will select the best resolution match to display on the TV. You can override this setting if you wish. Refer to your computer operating system's instructions for information on changing the screen resolution.

You may need to restart the computer for changes to take effect.

Distortion in Computer Images

Computer images may show distortion when viewed on the TV, e.g., lines that should be straight may appear slightly curved.

Using the TV with a Personal Computer, continued

Computer Display Formats

Press the **FORMAT** key repeatedly to cycle through the displays available for your computer's video signal.

Computer Signal	As Displayed on TV Screen			
	Original Format	4 X 3 Standard	16 X 9 Standard	Zoom
VGA 640 X 480				
SVGA 800 X 600				

Original Format	Standard	Zoom
XGA 1024 X 768		
PC 720p 1280 X 720		
WXGA 1360 X 768		

Original Format	Standard	Reduce
PC 1080p 1920 X 1080		

Status Display

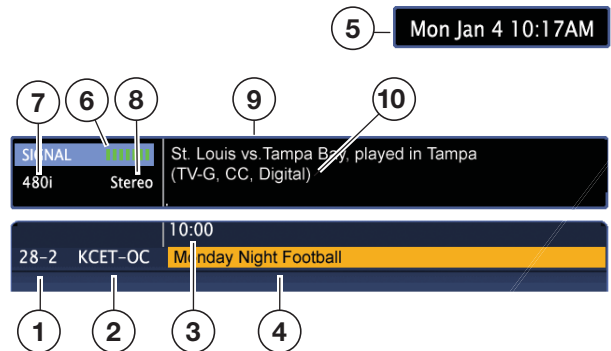
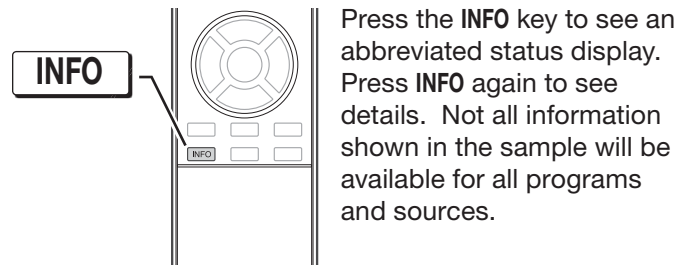

Basic Status Display

1. Channel number. Digital channel includes major and sub-channel numbers.
2. Digital channel name (if broadcast)
3. Program start time (if broadcast, digital source only)
4. Program name (if broadcast); digital source only
5. Day and time (set clock in the **Setup > Clock** menu).

Detailed Status Display

Press **INFO** a second time to see details.

6. Signal-strength indicator (digital signal, antenna only)
7. Signal type being received. See "Signal Definitions" on this page.
8. Program audio indicator (antenna source only)
9. Program description (if broadcast); digital source only.
10. V-Chip rating, closed-captions indicator, program signal type (if broadcast)

Signal Definitions

480i: Standard-definition interlaced signals

480p: Progressive-scan enhanced-definition signals

HD 1080i and HD 720p: High-definition 16:9 (wide-screen) signals.

HD 1080p: High-definition signals from a PC or Blu-ray player, HDMI inputs only.

3D Video

To display 3D gaming or 3D cinema content, your Mitsubishi TV requires:

- A compatible 3D source device outputting a 3D signal in checkerboard format, 1080p, 60-Hz; lower resolutions may be supported but will not fill the screen.
- Active-shutter 3D glasses, DLP link type or IR emitter type with matching emitter.

Initial Setup

1. If your 3D glasses came with an emitter, connect the emitter to the **3D GLASSES EMITTER** jack. Place the box in front of the TV where there is a clear path to the glasses.

Notes:

- If you require a Mitsubishi 3D adapter, refer to the connection instructions provided with the adapter. Please check our website, www.mitsubishi-tv.com for updates to 3D information and safety.
- If your glasses are marked **DLP Link**, skip this step; no emitter is required with DLP Link technology.

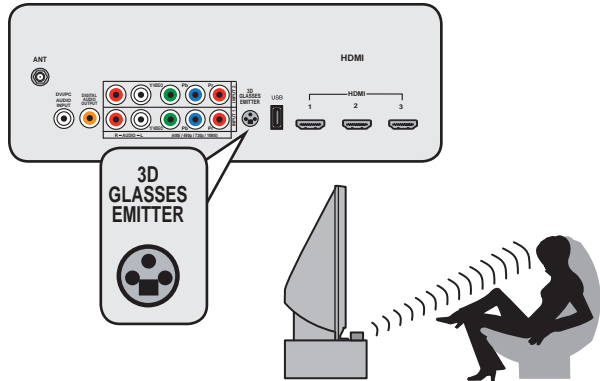

2. Connect the 3D video device to the TV's HDMI input.

Watching 3D Video

Note: Active 3D glasses are required.

1. Connect your 3D video device to one of the TV's HDMI inputs and power on the device.
2. Press **INPUT**.
3. Highlight the 3D video input and press **ENTER** to switch to it.
4. Press **MENU** and select the **Setup > 3D Mode** menu.
5. Highlight **3D Mode** and press **ENTER** to select **On**. The **On** setting will be memorized for the current input when you exit this menu.
6. If using DLP Link-type glasses, highlight **DLP Link** and press **ENTER** to select **ON**.

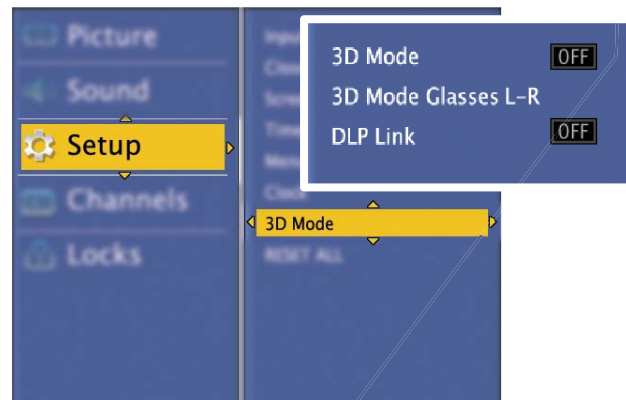

Use the **Setup > 3D Mode** menu to enable 3D video.

7. Press **EXIT** to close the menu.
8. If the image does not appear correct (e.g., objects appear to be moving in instead of out), open the **Setup > 3D Mode** menu and highlight **3D Mode Glasses L-R**. Press **ENTER** to change to **Reverse**.

To Watch Regular (non-3D) Video

The **3D Mode** setting is memorized for each input. When you want to watch non-3D video on the input selected above, open the **Setup > 3D Mode** menu and set **3D Mode** to **Off**.

Notice Concerning Format Compatibility

In order to display 3D images, Mitsubishi 3D Ready DLP Home Cinema TVs require the use of a 3D source device coupled with the Mitsubishi 3D adapter or other source devices that support checkerboard display formats for

display of 3D games, 3D broadcasts from terrestrial/cable/satellite and 3D Blu-Ray disc content. In all cases an emitter and matching 3D active shutter glasses or DLP Link active shutter glasses are required in order to view 3D content.

3D Video, continued

3D Safety Requirements

- 3D Glasses are NOT designed as sunglasses or safety glasses and do not provide protection. 3D glasses should be worn only when viewing 3D material.
- Do not wear the wireless glasses in any situations that require unimpaired visual perception.
- Children under the age of 5 should not view 3D programming.

Under normal conditions, 3D viewing is safe for your movies or games. Some people may experience discomfort, however. To minimize the potential for experiencing visual problems or any adverse symptoms:

- Read and follow any and all safety warnings that accompany your 3D glasses or 3D source devices.
- Maintain a distance of no less than 2 to 2.5 times the screen height measurement away from the display. Viewing from too short a distance can strain your eyes.
- Take regular breaks, at least 5 minutes after every hour of 3D viewing.

If you experience any of the following symptoms, discontinue 3D viewing until the symptoms go away:

- nausea, dizziness, or queasiness,
- headache, or eyestrain,
- blurry vision,
- double vision that lasts longer than a few seconds,

Do not engage in any potentially hazardous activity (for example, driving a vehicle) until your symptoms have completely gone away. If symptoms persist, discontinue use and do not resume 3D viewing without discussing your symptoms with a physician.

Do not use the glasses where loss of balance or limiting your field of vision may be dangerous to you.

Do not use near staircases, ledges or balconies. You may risk falling during or after use.

Epilepsy

WARNING! IF YOU OR ANY MEMBER OF YOUR FAMILY HAS A HISTORY OF EPILEPSY, CONSULT A PHYSICIAN BEFORE USING 3D VIDEO OR GAME PRODUCTS.

A small percentage of the population may experience epileptic seizures when viewing certain types of TV images or video games that contain flashing patterns of light.

The following people should consult a physician before viewing 3D Games or Video:

- Anyone with a history of epilepsy, or who has a family member with a history of epilepsy
- Anyone who has ever experienced epileptic seizures or sensory disturbances triggered by flashing light effects.

WARNING! SOME LIGHT PATTERNS MAY INDUCE SEIZURES IN PERSONS WITH NO PRIOR HISTORY OF EPILEPSY. DISCONTINUE 3D VIEWING IF YOU EXPERIENCE ANY OF THE FOLLOWING SYMPTOMS:

- Involuntary movements, eye or muscle twitching
- Muscle cramps
- Nausea, dizziness, or queasiness
- Convulsions
- Disorientation, confusion, or loss of awareness of your surroundings

Do not engage in any potentially hazardous activity (for example, driving a vehicle) until your symptoms have completely gone away.

Do not resume 3D viewing without discussing the symptoms with your physician.

2 TV Connections

Connection Panel

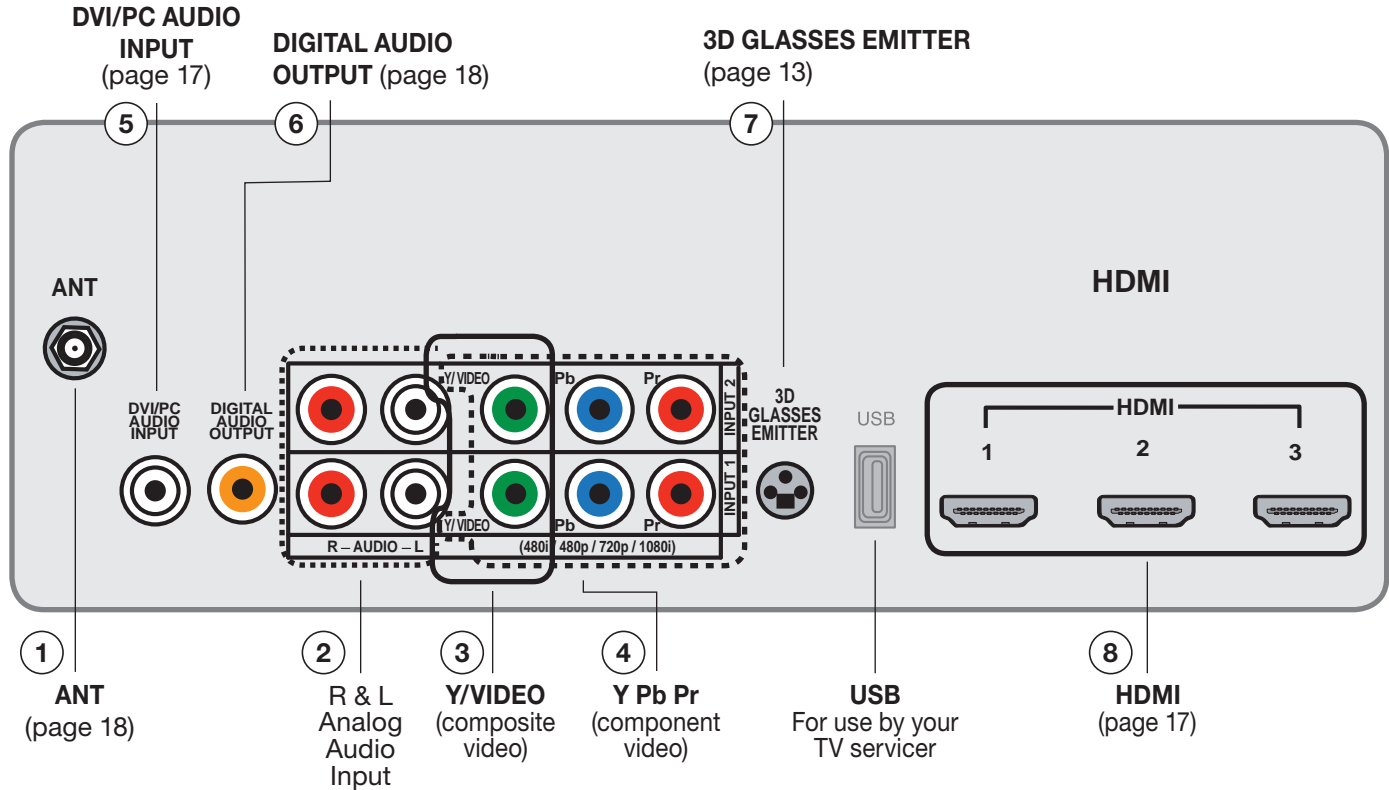

1. ANT (Antenna)

Connect your main antenna or direct cable service (no cable box) to **ANT**. The **ANT** input can receive digital and analog over-the-air channels from a VHF/UHF antenna or non-scrambled digital/analog cable source.

2. Right and Left Analog Audio Inputs

Use with **INPUT 1/2** composite or component video inputs.

3. Y/VIDEO (Composite Video)

Connect devices with composite video output to these inputs. Use the adjacent **AUDIO R** and **L** inputs if you wish to send audio to the TV.

4. Y Pb Pr (Component Video)

Connect devices with component video outputs to this jack. Use the adjacent **AUDIO R** and **L** jacks if you wish to send audio to the TV.

5. DVI/PC AUDIO INPUT

When connecting a DVI device to one of the TV's HDMI inputs, use this stereo mini-jack for analog audio.

6. DIGITAL AUDIO OUTPUT

This output sends Dolby Digital or PCM digital audio to your digital A/V surround sound receiver. Incoming analog audio is converted by the TV to PCM digital audio. If you have a digital A/V receiver, in most cases this is the only audio connection needed between the TV and your A/V receiver. Dolby Digital audio is available only from digital channels received on the antenna input.

7. 3D GLASSES EMITTER

Use this jack for the special IR emitter supplied with 3D glasses. The emitter will send a signal that synchronizes your 3D glasses with the screen display. See page 13

8. HDMI™ Inputs (High-Definition Multimedia Interface)

The HDMI inputs support uncompressed standard and high-definition digital video formats and PCM digital stereo audio.

Mitsubishi recommends you use high-speed HDMI cables when connecting newer HDMI source devices. High-speed cables bring you the full benefits of Deep Color.

Connection Panel, continued

The HDMI inputs can also accept digital DVI video signals. To connect a device's DVI output to the TV's HDMI input, use an HDMI-to-DVI adapter or cable plus an analog audio cable. Connect the analog audio cables to the **DVI/PC AUDIO INPUT** jacks on the TV to receive audio from your DVI device.

Use the HDMI inputs to connect to CEA-861 HDMI compliant devices such as a high-definition receiver or DVD player. These inputs support 480i, 480p, 720p, 1080i, and 1080p video formats.

The TV's HDMI inputs are compatible with many DVI-D and HDMI computer video signals.

These inputs are HDCP (High-Bandwidth Digital Copy Protection) compliant.

HDMI Cable Categories

HDMI cables are available as standard and high-speed types.

- **High-Speed HDMI Cables.** Newer DVD players, video games, and set-top boxes require high-speed cables, suitable for clock frequencies up to 340 MHz or data rates of up to 10.2 gigabits per second. Use high-speed cables for high-speed 1080p HD signals carrying extended color encodings (i.e., 30 or more bits, also called Deep Color). High-speed cables are also suitable for standard HDTV signals.
- **Standard HDMI Cables.** Standard HDMI cables may be unmarked. They are suitable for standard HDTV 720p, 1080i, and 1080p signals with 8-bit color depth. Use standard HDMI cables for clock frequencies up to 74.25 MHz or data rates of up to 2.23 gigabits per second.

Connection Types and Audio/Video Quality

Connection Types

Use the connection types available on your input devices that will give the best video quality. For example, choose HDMI over component video; choose component video over composite video.

Picture Quality

For best picture quality, route signals directly from the input device to the TV whenever possible.

Surround Sound

For best surround sound audio quality, route audio-carrying cables from the source device directly to your A/V receiver or sound system.

Note

Accessory items such as cables, adapters, splitters, or combiners required for TV connections are not supplied with the TV. These items are available at most electronics stores.

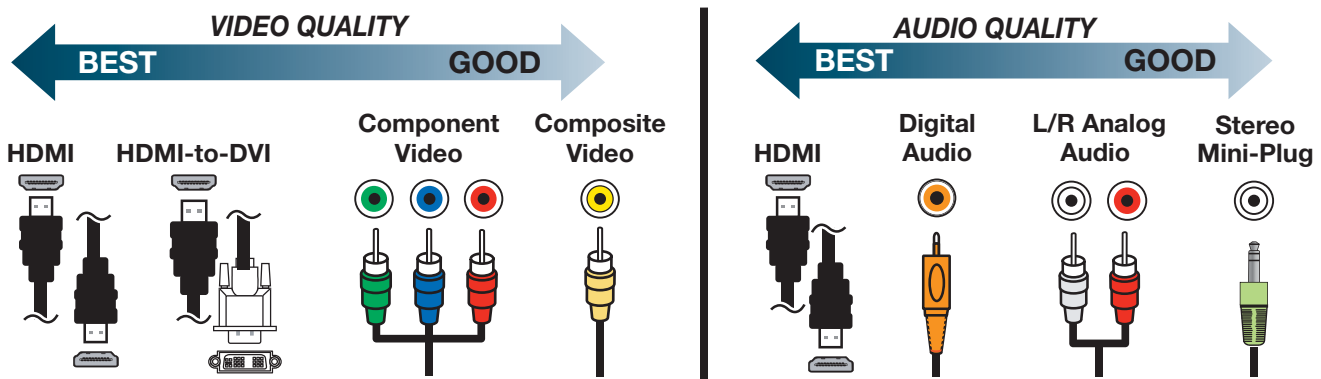

HDMI Device

Mitsubishi recommends using high-speed HDMI cables to connect newer devices incorporating HDMI technology.

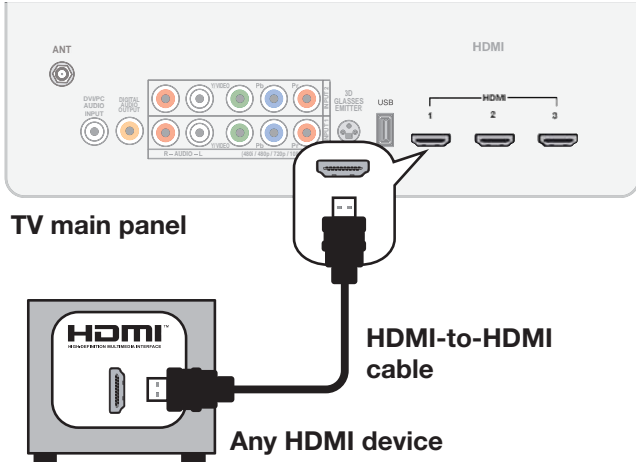

IMPORTANT

HDMI and Audio Signals

Digital Surround Sound: The TV's HDMI inputs can receive digital stereo audio signals only. To hear digital surround sound from an HDMI device, connect the device's HDMI or digital audio output directly to your A/V receiver. See the Owner's Guides for those devices for instructions.

DVI Video Device

Required:

- DVI-to-HDMI cable or DVI/HDMI adapter and HDMI cable
- Analog audio cable with stereo mini-plugs

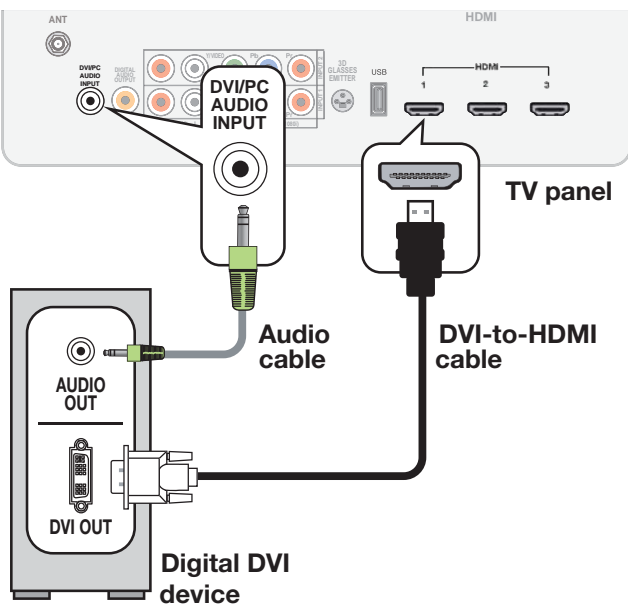

Y Pb Pr Component Video Device

Required:

- RCA-type component video cables
- Left/right analog audio cables

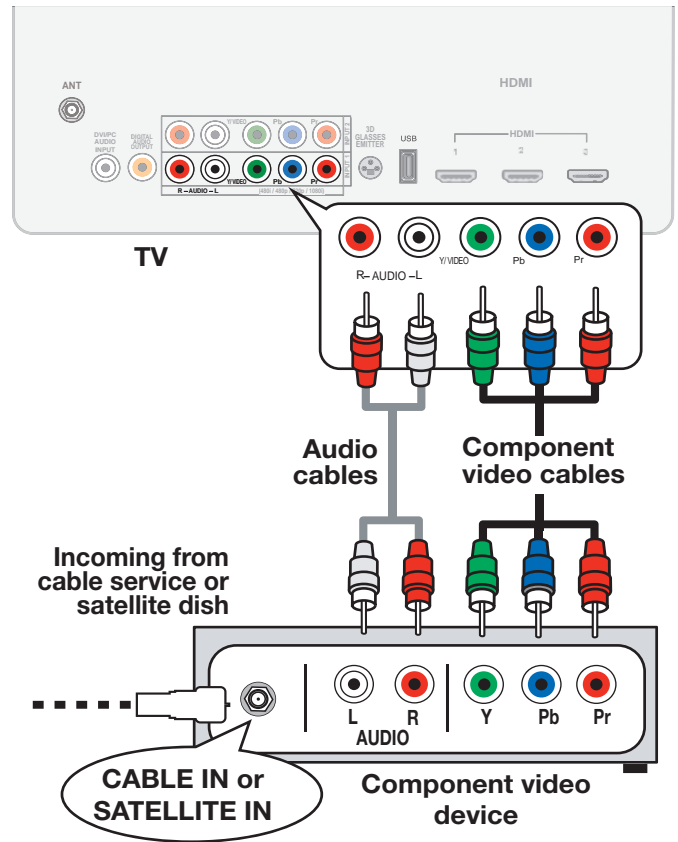

Composite Video Device

Required:

- Composite video cable (usually yellow)
- Left/right analog audio cables

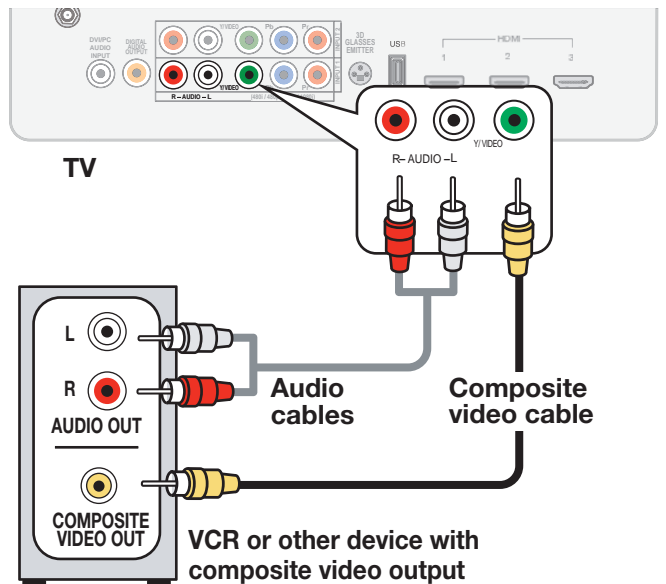

Antenna or Cable TV Service

Connect the incoming cable to the TV's **ANT** input.

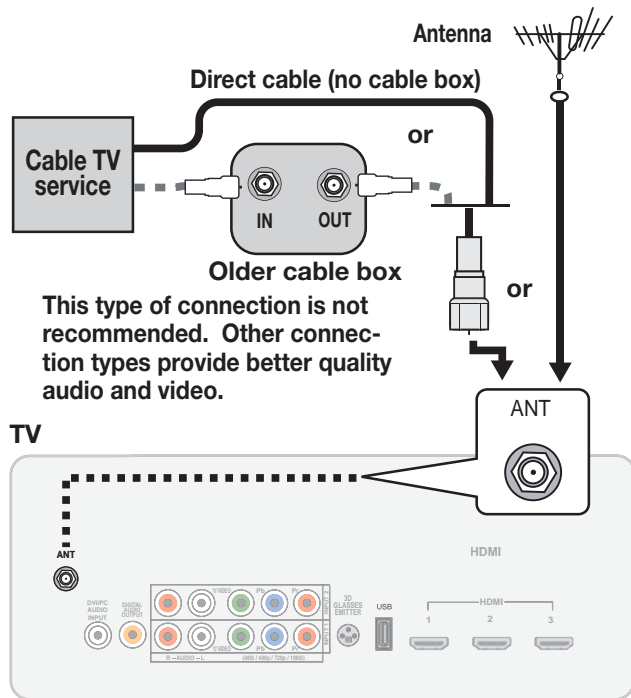

A/V Receiver with Coaxial Input

This connection sends audio from the TV to an external sound system. You must use this connection if you want to send audio to a sound system from

- TV broadcasts received on the **ANT** input
- Devices connected directly to the TV

Note: On rare occasions, an HDMI signal may be copy-restricted and cannot be output from the TV as a digital signal.

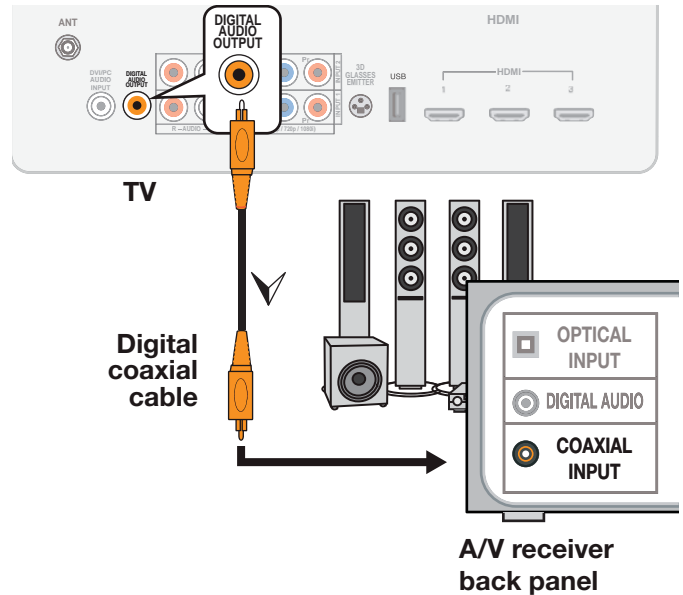

VCR or DVD Recorder to an Antenna or Wall Outlet Cable

Required:

1. Video cables
 - 1a. Component video cables (red/blue/green)
 - or
 - 1b. Composite video cable (usually yellow)
2. Left/right analog audio cables.
3. Two-way RF splitter
4. Two coaxial cables

Note: If your recording device has an analog-only tuner, you must use a digital converter box to enable recording of digital broadcasts.

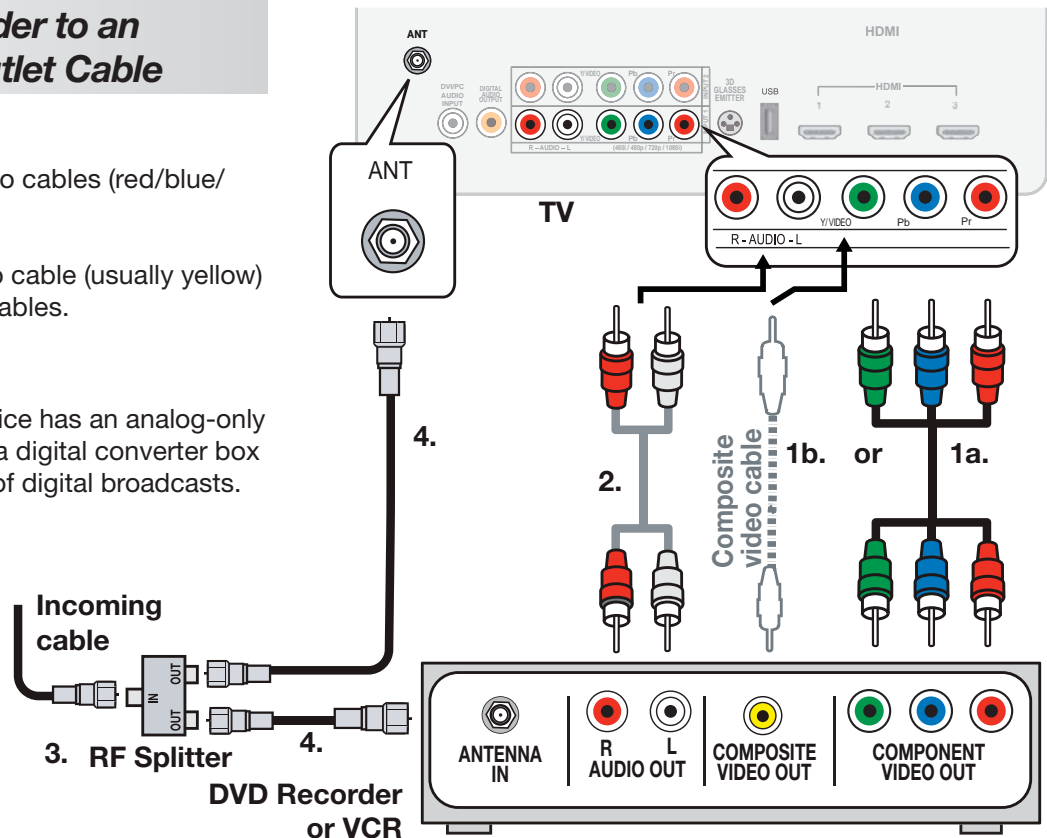

A/V Receiver with HDMI Output

Required: One HDMI-to-HDMI cable

This option allows you to view content from devices connected to an A/V receiver. The A/V receiver can send audio and video to the TV over a single HDMI cable. You can use an HDMI connection as described here in addition to an audio connection from the TV's audio output. The optional audio connection allows you to hear, through the A/V receiver, devices connected to the TV only, e.g., an antenna on the **ANT** input.

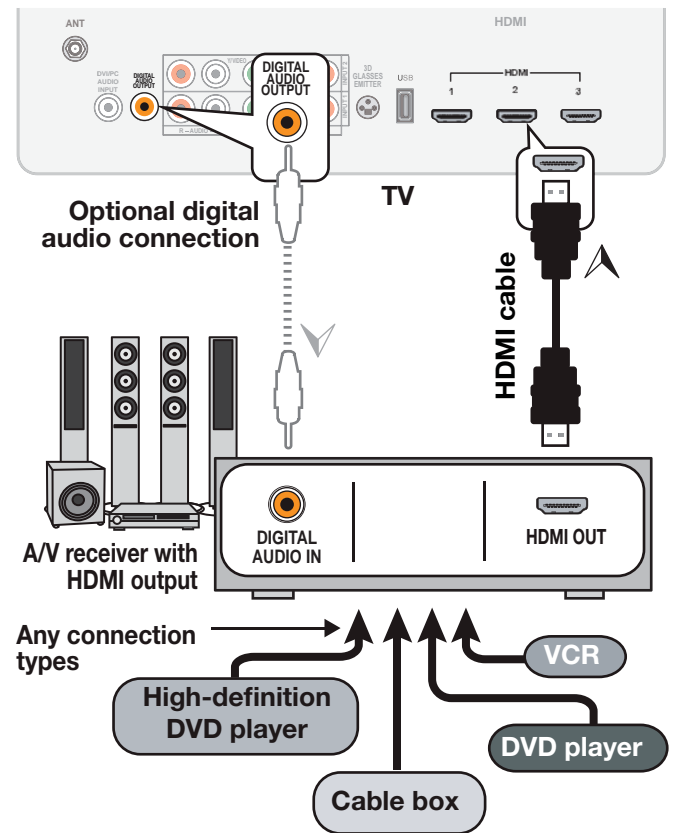

3 TV Menus

Press **MENU** on the remote control to open the main menu.

- Press **ENTER** or **▶** to see sub-menus.
- Press **MENU** or **◀** to back up one menu level.
- Press **EXIT** to close all menus.

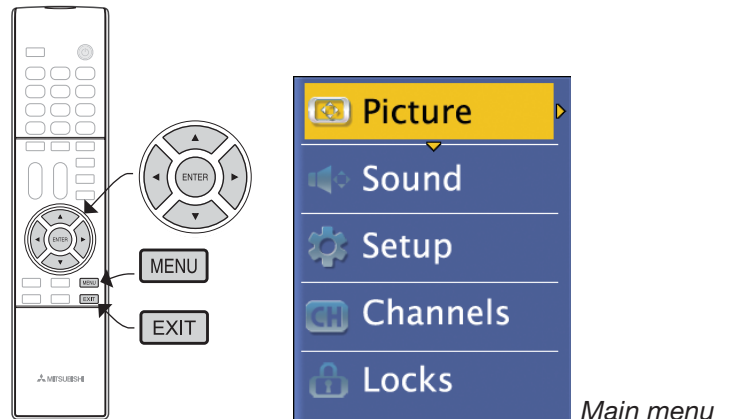

Picture

Picture Settings

Picture settings are saved for the current input only.

Using the Picture Settings Menu

1. Highlight the item you want to change and press **ENTER** to display an adjustable slider or a list of settings.
2. Make changes, then press **ENTER** to return to this menu.
3. When done, highlight **Done** and press **ENTER**.

To return to the default settings, highlight **Reset** and press **ENTER**.

Picture Mode

Set the Picture Mode before changing other video settings. Use Picture Modes to get the best image under different viewing conditions.

Mode	Conditions
Brilliant	Bright light
Bright	Most daytime viewing
Natural	Most nighttime viewing
Game	Optimizes picture and video processing for game consoles.

Brightness

Adjusts overall picture brightness.

Contrast

In most home lighting situations, medium contrast looks best.

Color

Adjusts overall color intensity from monochromatic to fully saturated.

Tint

Adjusts the red-to-green ratio.

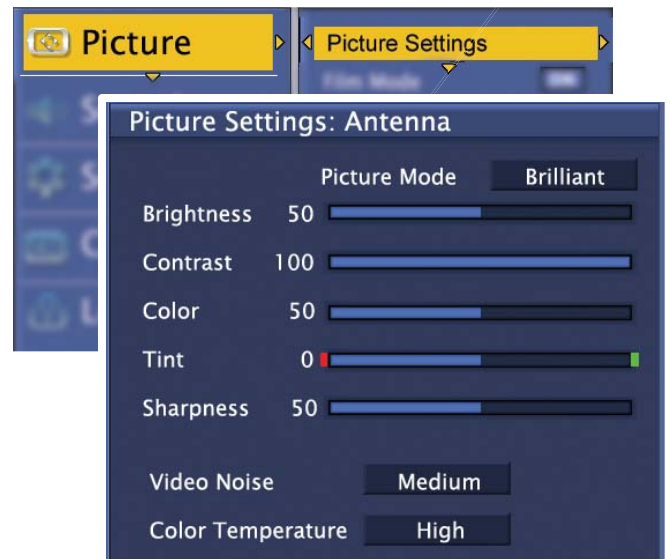

Sharpness

Adjusts picture detail and clarity.

Video Noise

Reduces minor noise (graininess) in the picture.

Color Temperature

High gives a white a cool (blue) cast. **Low** gives white a warm (amber) cast.

Film Mode

480i and 1080i signals only. Press **ENTER** to turn on or off. When active, the TV applies film-decoding correction to movies filmed at 24 frames per second. Try turning it off if images show many jagged edges.

Reset Picture

Returns to default settings, current input only.

For assistance call 1(800) 332-2119

Sound



Sound menu

Audio Settings

Audio settings are saved for the current input only.

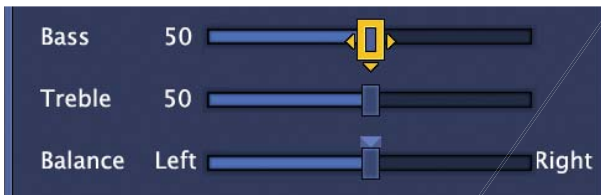

Using the Audio Settings menu

1. Highlight the slider you want to change and press ◀ ▶ to make adjustments.
2. Press **ENTER** when done.

Level Sound

Smooths and levels sound volume across source and channel changes. Press **ENTER** to turn on or off.

Analog Listen To

Available only for analog channels from the antenna input.

Mono	Reduces background noise. Use when receiving a weak stereo audio signal.
Stereo	The TV plays stereo broadcasts in stereo and mono broadcasts in mono.
SAP	Second Audio Program. Selects an additional monaural sound track (if available).

Language

Select the default language track for a digital program from the antenna input (limited to languages available).

TV Speaker

Switch TV speakers off when listening to sound through an external audio system. Highlight **TV Speaker** and press **ENTER** to switch TV speakers on or off.

Reset Audio

Returns to default settings, current input only.

Setup

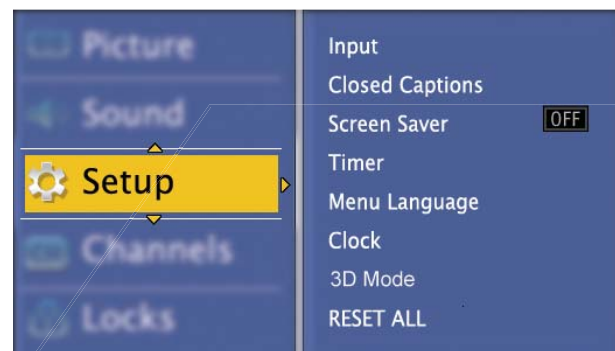

Setup menu

Input

Change input name assignments or remove inputs from the input list. See page 8.

Closed Captions

The TV can decode captions from the antenna input (digital and analog channels) and from the composite video jacks (originally analog content only).

Services	Off/On/On if Mute Select On if Mute to display closed-caption signal Caption 1 (digital) or CC1 (analog) when audio from the TV speakers is muted.
Analog Captions	<ul style="list-style-type: none"> • CC 1–CC 4. Standard closed-caption signals • Text 1–Text 4. Text-service signals
Digital Captions	Caption 1–Caption 6: Caption signals sent by the broadcaster.

Digital Appearance

- A white font on a black translucent background makes an easy-to-read combination.
- Always use contrasting colors for captions and background.



Settings for digital closed captions

1. Highlight the item you want to change and press **ENTER** to display a list of settings.
2. Press ▲ ▼ to make a selection.
3. Press **ENTER** to return to the menu.
4. Highlight **Done** and press **ENTER**.

For assistance call 1(800) 332-2119

Setup, continued

Screen Saver

When on, displays a randomly moving Mitsubishi logo after one minute without activity or a video signal. The logo reminds you that the TV is still on. Press **ENTER** to choose either **On** or **Off**.

Timer

The Timer tells the TV to power on automatically at a time you set. Use this menu to set a day, time, input, and channel for the Timer. If the TV is already on at the set time, the TV will automatically change to the designated channel or input.

- The TV clock must be set before you can use the Timer feature.
- As a reminder that the TV Timer is set, the **STATUS** indicator blinks slowly while the TV is powered off.

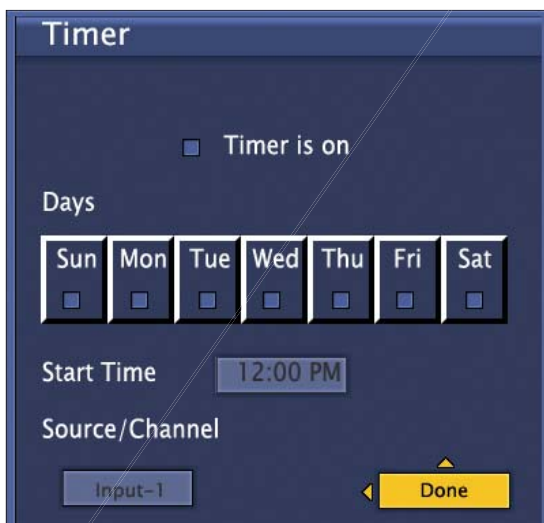

1. Highlight the item you want to change and press **ENTER** to display a list of settings.
2. Press **▲▼** to make a selection.
3. Press **ENTER** to return to the menu.
4. Highlight **Done** and press **ENTER**.

Menu Language

Highlight either **English** or **Spanish** and press **ENTER** to confirm your selection.

Clock

Set the clock if you want to

- Use the TV's auto-on timer.)
- Display current time in the on-screen status.

If Daylight Saving Time is observed in your area, check or uncheck the box when the time change occurs.

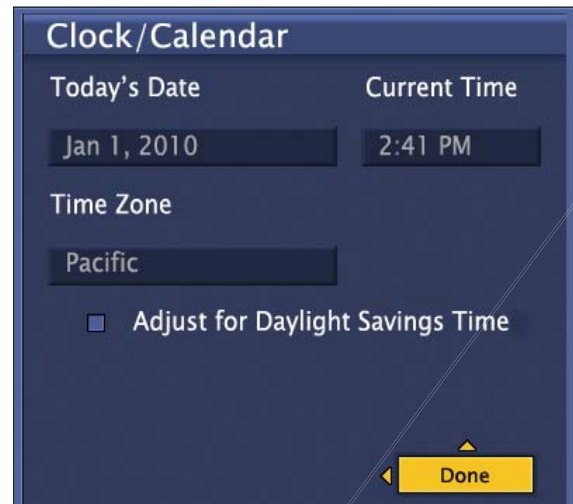

1. In the **Setup > Clock** menu, highlight the item you want to change.
2. Press **ENTER** for adjustment mode.
3. Highlight the correct setting in the list. For the time and date, use **▲▼** to change and **◀▶** to move. You can also enter digits for the time.



4. Press **ENTER** to confirm your entry and return to the **Clock** menu.
5. Highlight **Done** and press **ENTER**.

3D Mode

See page 13 for use of this menu.

RESET ALL

Sets all user-defined settings to the factory defaults and runs the initial guided setup. To prevent accidental use of **RESET ALL**, set a pass code (PIN) in the **Locks** menu. See page 24.

Channels

Use the TV's channel menus to:

- Save a list of favorite channels (see page 10).
- Define the source for the antenna input
- Perform a channel scan
- Limit **CH**^/**CH**∇ tuning to only the channels you want
- Selectively scan for new channels
- Add a single channel by RF channel number

Favorites

See page 10 for use of the **Favorites** menu.

Editing the Channel List

- Use the **Channel Edit** menu so the TV tunes only to the selected channels when using the **CH** ^/∇ key.
- Channels marked with a check are in memory.
- Press ▲ ▼ to move through channel numbers one at a time.
- To add or delete a channel from memory, highlight the channel number and press **ENTER** to remove the check.
- To jump to a channel, enter the channel number, including separator, and press **ENTER**. For example, to jump to 36-1: **3** **6** **CANCEL** **1** **ENTER**.
- Use the **Mark All** or **Unmark All** options if working with many channel numbers.



Enter the channel number to jump quickly to a channel. Checked channels can be tuned with the **CH** ^/∇ key.

Changing the Channel Source

Highlight the source connected to the TV's antenna input.

- **Air** if you have an over-the-air antenna
- **Cable** if you have direct cable service without a box.

Press **ENTER** to confirm your selection.

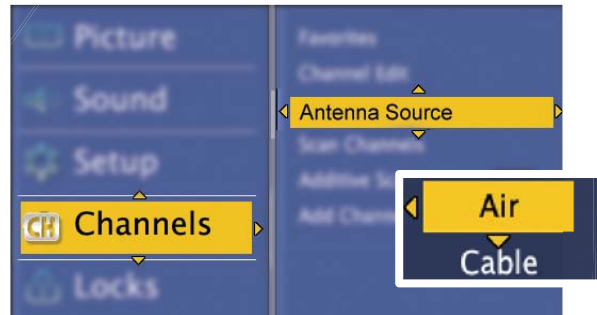

Scanning Channels

Perform a channel scan after

- Initializing the TV
- Changing the source (switching between an over-the-air antenna and direct cable service)
- Repositioning the antenna
- Transporting the TV to a different area

The channel scan will erase all custom channel settings (channel locks, favorite channels, channel-list edits).

Note: **Additive Scan** must be **OFF** to enable a full channel scan.

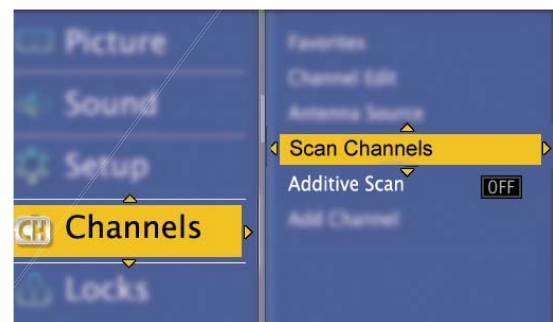

Channels, continued

Additive Scan

The additive scan adds only new channels. Unlike the full channel scan, custom channel settings are preserved.

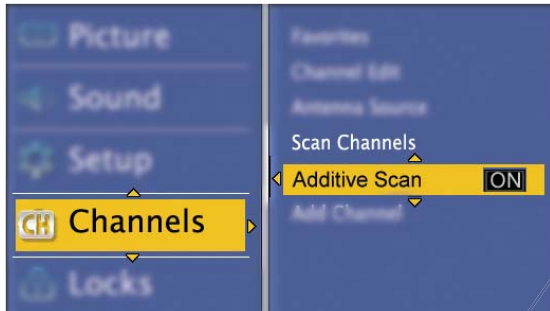

1. Highlight **Additive Scan** and press **ENTER** to select either **ON** or **OFF**.
2. Highlight **Scan Channels** and press **ENTER** to start the additive scan.

Adding a Channel

You can manually add a new channel using the **Add Channel** menu. This menu requires you to enter the RF channel number. The RF channel number is available from:

- www.antennaweb.org
- The broadcaster
- Your cable-service provider

Enter the RF channel number using keys on the remote control.

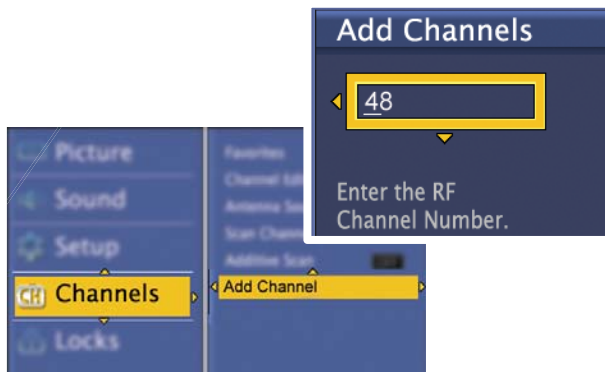

Locks

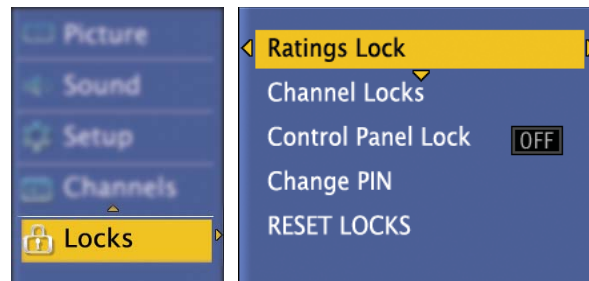

PIN

You will be prompted to enter a 4-digit personal identification number (PIN) when you

- Select **Locks** on the main menu.
- Try to watch a blocked program
- Tune to a locked channel

Enter your PIN to temporarily unlock the TV and watch the blocked program or channel. Power the TV off and then back on to re-activate channel locks.

Ratings Lock

Rating locks restricts access using ratings sent by broadcasters. There are separate rating systems for movies and television programs. The TV comes from the factory with the rating locks turned off. You must turn on blocking to activate rating restrictions.

TV Ratings

Highlight the rating level you wish to change and press **ENTER** to block/unblock.

Apply supplemental content blocking to the age-based ratings by using the TV content categories **FV**, **D**, **L**, **S**, **V**.

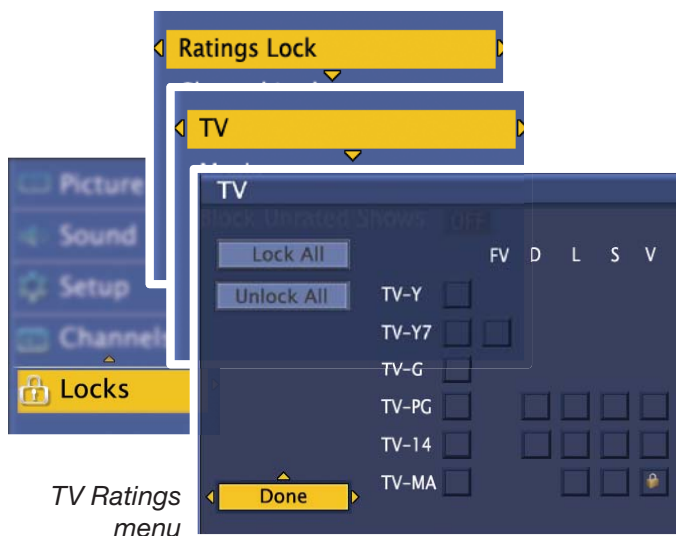

TV Ratings menu

Locks, continued

TV Program Ratings

TV Age-Based Ratings	TV-Y	Youth. For children under 7.
	TV-Y7	Youth 7 and older.
	TV-G	General Audience. For the entire family.
	TV-PG	Parental Guidance. Parental Guidance recommended; may not be suitable for some children.
	TV-14	Adolescent 14 and older. Not recommended for children under 14.
	TV-MA	Mature Audience. For adults only.
TV Content Categories	FV	Fantasy Violence. Applies to TV-Y7 only.
	D	Sexual Dialog. Applies in differing degrees to TV-PG and TV-14.
	L	Adult Language. Applies in differing degrees to TV-PG, TV-14, and TV-MA.
	S	Sexual Situations. Applies in differing degrees to TV-PG, TV-14, and TV-MA.
	V	Violence (graphic or realistic). Applies in differing degrees to TV-PG, TV-14, and TV-MA.

Important Notes on Rating Locks

- Rating locks apply only to channels and signals received on the **ANT** and composite **VIDEO** jacks.
- When viewing a cable box, satellite receiver, or other device connected to the component **Y Pb Pr** or **HDMI** inputs, check the device's owner's guide for parental locks.

Movie Ratings

Highlight the rating level you wish to change and press **ENTER** to block/unblock.

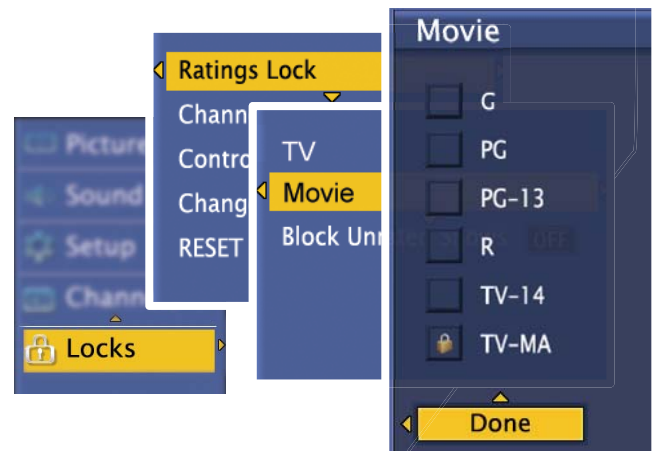

Movie Ratings menu

Movie Ratings

G	General Audience. Designed for the entire family.
PG	Parental Guidance. Parental Guidance recommended; may not be suitable for some children.
PG-13	Parental Guidance, 13 and Older. Not recommended for children under 13.
R	Restricted. Restricted in theaters to 17 years old and older unless accompanied by an adult.
NC-17	No Children 17 or Under. Restricted in theaters to 18 years old and older.
X	Adult. Designed for and restricted in theaters to adult audiences only.
Not Rated	No MPAA rating assigned

Block Unrated Shows

Highlight **Block Unrated Shows** and press **ENTER** to turn blocking either on or off.

When on, blocks programs that are not rated, such as news, sports, weather, emergency bulletins, or movies prior to or without MPAA Ratings. Use care when blocking programming that is not rated.

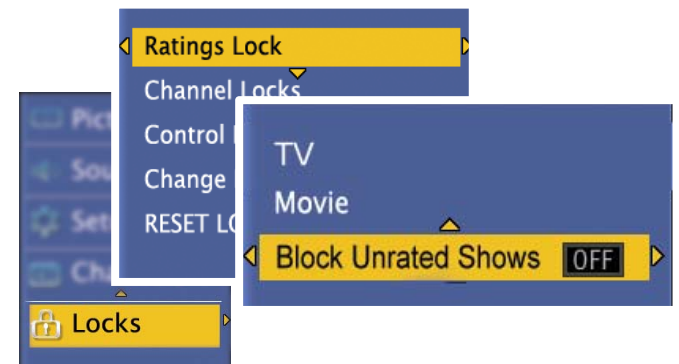

Locks, continued

Channel Locks

Block access to the channels you specify.

- Highlight the control box next to the channel number and press **ENTER** to lock or unlock the channel.
- Use the **Lock All** and **Unlock All** options if working with many channel numbers.



Control Panel Lock

Use this lock if small children are present who may try to press the buttons.

- Highlight **Control Panel Lock** and press **ENTER** to lock/unlock the TV's control panel.
- To unlock the panel without the remote control, unplug the TV from AC power for a few moments.

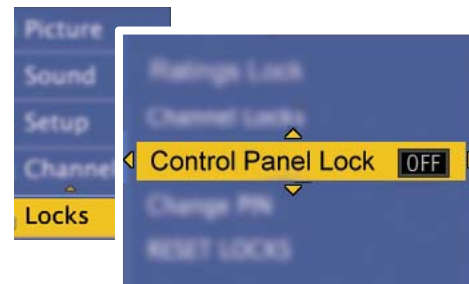

Change PIN

Use the remote control's number keys to set a new PIN.

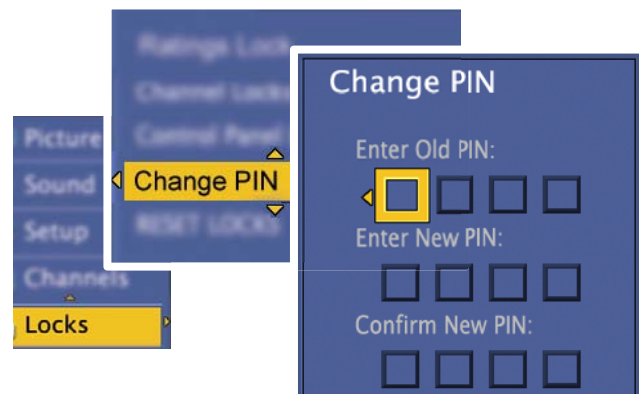

RESET LOCKS

Use this option to clear all custom lock settings and return to the TV's default lock settings. If you have forgotten your PIN, see the reset section in Appendix B.

Appendix A: TV Care

Lamp-Cartridge Replacement

CAUTION: If the television is on, press **POWER** to turn it off. Unplug the television and allow it to cool for at least one hour before attempting to replace the lamp cartridge.

Lamp

The light source for this television is a lamp, which is part of a lamp cartridge assembly. The life of the lamp can vary, based on the lamp itself, the air temperature around the TV while it is operating, the selected lamp mode, and your viewing patterns. Warmer air or poor ventilation shorten the lamp life, as does turning the television on and off frequently.

Mitsubishi warrants the lamp for one (1) year from the date of original TV purchase at retail.

Ordering a New Lamp

To Receive a Replacement Lamp Under Warranty

- Visit our website at www.mitsuparts.com.
- Call (800) 553-7278. Please have model number, serial number, and TV purchase date available.

Important: All lamps replaced under warranty must be returned to Mitsubishi where they will be inspected to verify failure defects.

To Purchase a Replacement Lamp After Warranty

Visit our website at www.mitsuparts.com or call (800) 553-7278. Order the following:

Lamp Part Number 915B441001

Lamp-Substitution Alert



MDEA recommends that you use only genuine Replacement Lamp Assemblies purchased directly from Mitsubishi or a Mitsubishi Authorized Dealer or Mitsubishi Authorized Service Center. MDEA advises that replacement lamps obtained separately from the Lamp Cartridge and/or Lamp Assemblies obtained from unauthorized sellers may be incorrect for your television, may not fit or perform properly and may even damage your television. MDEA can not be responsible for the performance, reliability or safety of any replacement lamps that are obtained from unauthorized sources.

WARNING

- Do not remove the lamp cartridge immediately after turning off the television. You may get burned because the lamp is very hot. Allow the television to cool for at least one hour before replacing the lamp cartridge.
- Do not remove the lamp cartridge except when replacing it. Careless treatment can result in injury or fire.
- Do not touch the lamp glass element. It may be very hot and break, causing injuries or burns.
- Be sure not to insert any metal or flammable object into the lamp cartridge opening, as it may cause fire or electrical shock. If a foreign object is inserted into the opening, unplug the AC cord of the TV and contact your dealer for service.
- Install the lamp cartridge securely. Failure to do so may cause a fire.
- Do not touch the lamp glass elements. Oils from your fingers may cause premature lamp failure.

 = MERCURY

THE LAMP INSIDE THIS PRODUCT CONTAINS MERCURY AND MUST BE RECYCLED OR DISPOSED OF ACCORDING TO LOCAL, STATE OR FEDERAL LAWS. For disposal or recycling information, please contact your local authorities or the Electronic Industries Alliance at www.eiae.org

CAUTION

BURN DANGER! HOT SURFACES INSIDE!
Touch lamp cartridge handle only. Do not touch lamp or lamp cartridge housing. Keep lamp cartridge horizontal during removal. Do not tilt as glass may come out and cause injury. Replace lamp cartridge only with the same part number 915B441001.

WARNING

THE ACCESS PANEL IS PROVIDED WITH AN INTERLOCK TO REDUCE THE RISK OF EXCESSIVE ULTRAVIOLET RADIATION. DO NOT DEFEAT ITS PURPOSE OR ATTEMPT TO SERVICE WITHOUT REMOVING PANEL COMPLETELY.

Appendix A: TV Care, continued

Lamp-Cartridge Replacement

Removing the Old Lamp Cartridge

1. Turn off TV power and unplug the TV. Allow the lamp to cool for at least one hour before proceeding.
2. After the lamp has cooled, remove the cover of the lamp compartment, located on the back of the TV. Refer to figures 1 and 2. Use a #2 (medium) Phillips screwdriver to loosen the screw securing the cover. Keep the screw and cover for re-installation.
3. With a medium Phillips screwdriver, loosen the two screws securing the lamp cartridge until they disengage from the mating threads. These are captive screws and cannot be separated from the lamp cartridge.
4. Fully open the bag supplied with the replacement lamp and set the opened bag aside.
5. Gently grasp the handle of the lamp cartridge and pull the old cartridge straight out. See figure 3.

CAUTION: Do not tilt or rotate the cartridge, as small glass fragments may fall out.

6. Without tilting or putting down the lamp cartridge, insert it into the opened bag. Close the bag while being careful not to let any glass particles fall out.

Installing the New Lamp Cartridge

1. Do not touch the glass parts of the new lamp cartridge. Insert the new cartridge into the TV in the same orientation as the old cartridge. Push on the cartridge housing until it is fully seated.
2. Gently tighten the screws with the screwdriver. **AVOID OVERTIGHTENING!**
3. Replace the plastic cover and retaining screws.
4. **WASH YOUR HANDS THOROUGHLY, AS THIS LAMP CONTAINS MERCURY.**

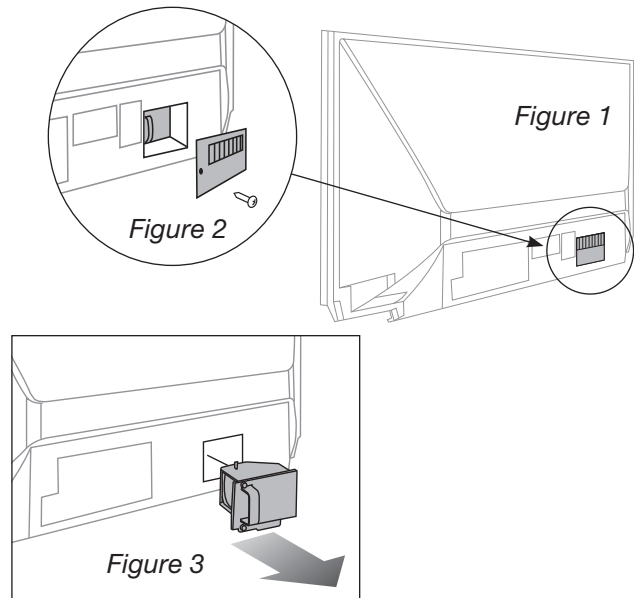

Use only replacement lamp part number 915B441001.

Disposal of the Old Lamp Cartridge

Lamp under warranty: All lamps replaced under warranty must be returned to Mitsubishi. Use the return shipping label provided and send to Mitsubishi Digital Electronics, America, 625 Braselton Parkway, Suite 200, Braselton, GA 30517.

IMPORTANT: Lamps found without defects will be returned and charged back to the sender.

Lamp no longer under warranty: Contact your local authorities or the Electronic Industries Alliance at www.eiae.org for lamp-disposal or recycling instructions. Do not dispose of the old lamp with common trash.

Appendix A: TV Care, continued

Cleaning Recommendations

Normally, light dusting with a dry, non-scratching duster will keep your TV clean. If cleaning beyond this is needed, please use the following guidelines:

First, turn off the TV and unplug the power cord from the power outlet.

Exterior

Occasionally clean dust and debris build-up from the air-intake grilles on the back and sides of the TV. Clean using a vacuum cleaner with a brush attachment.

Top and Sides of the TV

- Gently wipe down your TV with a soft, non-abrasive cloth such as cotton flannel, microfiber, or a clean cloth diaper, lightly moistened with water. Dry with a second dry, soft, non-abrasive cloth.
- For oily dirt, add a few drops of mild liquid detergent, such as dishwashing detergent, to the water used to moisten the cloth. Rinse with a second cloth moistened only with water. Dry with a third dry, soft, non-abrasive cloth.

Screen

- Follow the instructions for the top and sides, wiping gently in an up and down motion.
- Clean the entire screen evenly, not just sections of the screen.
- Do not allow liquid to drip down the screen, as some liquid may enter the TV through the gap between the screen and screen frame.
- You may purchase Mitsubishi Screen Cleaner, part number CLEANER-VSS, by calling (800) 553-7278.

General Cleaning Precautions

- DO NOT allow liquid to enter the TV through the ventilation slots or any crevice.
- DO NOT use any strong or abrasive cleaners, as these can scratch the surfaces.
- DO NOT use any cleaners containing ammonia, bleach, alcohol, benzene, or thinners, as these can dull the surfaces.
- DO NOT spray liquids or cleaners directly on the TV's surfaces.
- DO NOT scrub or rub the TV harshly. Wipe it gently.

Care of the Remote Control

Remote Control Tips

- For longer life, use alkaline batteries.
- Do not mix old and new batteries.
- Be within 20 feet of the equipment.
- Do not press two or more keys at the same time unless instructed to do so.
- Do not allow the unit to get wet or become heated.
- Keep the unit out of direct sunlight.
- Avoid dropping on hard surfaces.
- Do not use harsh chemicals to clean. Use only a soft, lightly moistened cloth.

Resetting the Remote Control

If **TV** mode is selected and the TV does not respond properly, reset the remote control.

1. Press and hold **POWER** for several seconds until the mode indicator blinks twice and goes off.
2. Release the **POWER** key.
3. Enter code **0 0 0 0 0** and the **POWER** key will blink twice when you finish entering the code. When entering the code, pause for a moment between each key press to ensure it is recognized.

Low-Battery Indicator

If you press a key and the mode indicator blinks five times, replace the remote control's batteries.

Appendix B: Troubleshooting

TV Reset Comparison Guide

You can resolve many common TV problems using the reset functions described in the following table.

IMPORTANT

Before you change sound or picture settings: If picture or sound settings seem wrong for a broadcast channel (a channel from the **ANT** input, a cable box,

or satellite receiver), first check other channels from the same input before changing settings. If most other channels from the same input seem correct, there is likely a problem with the broadcast rather than with the TV. Use care in this case, as changes you make to fix problems on individual channels also affect all other channels on the same input.

Reset Name	When to Use	How to Use	Resulting Action
Format	If the picture shape seems incorrect, use the FORMAT key to change the picture shape.	Press FORMAT to cycle through the available picture shapes for the signal.	The last-used format for a signal type will be recalled on the input. Note: Also check the aspect ratio feature on your cable box, satellite receiver, or other device, as this may be altering the picture.
Picture and Sound Resets (for the single current input)	When audio and/or video settings for a single input seem incorrect, use the reset option to return the input to the original factory settings.	<ol style="list-style-type: none"> 1. While viewing the input to reset, press MENU and go to Picture > Reset or Sound > Reset. 2. Press ENTER to reset. 	All picture or sound settings for the individual input are reset.
Channel Scan	To erase and re-memorize channels on the antenna input. Use after moving the TV to a new area or repositioning the antenna.	<ol style="list-style-type: none"> 1. Press MENU and go to Channels > Antenna Source. 2. Highlight the reception mode, either Cable or Air, and press ENTER. 3. Go to Channels > Scan Channels and start the channel scan. Be sure Additive Scan is set to OFF. 	All previously memorized channels for the antenna input are erased and a new set of memorized channels is created.
Locks Menu PIN	To change your Locks menu PIN	When prompted for the PIN, press the number 9 and LAST keys on the TV remote control at the same time.	Allows establishment of a new PIN.
TV Locks	To temporarily disable channel or ratings locks.	To use number keys only, press 6 4 8 7 .	Allows you to view a locked channel or program. Turn the TV off and then on to restore locks.

Service and Customer Support

Service

If you are unable to correct a problem with your TV, consult your Mitsubishi dealer or Mitsubishi Consumer Relations at (800) 332-2119.

- DO NOT adjust any controls other than those described in this Owner's Guide.
- DO NOT remove the protective back cover of your TV.

Customer Support

- To order replacement or additional remote controls or lamp cartridges, visit our website at www.mitsubishi-parts.com or call (800) 553-7278.
- For questions:
 - ◆ Call Consumer Relations at 800-332-2119.
 - ◆ E-mail: MDEAservice@mdea.com
 - ◆ Website: www.mitsubishi-tv.com

Important

All lamps replaced under warranty must be returned to Mitsubishi where they will be inspected to verify failure defects.

Appendix B: Troubleshooting, continued

Reset Name	When to Use	How to Use	Resulting Action
System Reset	If the TV does not turn on or off, does not respond to the remote control or control-panel buttons, or has audio but no video.	Press and hold the POWER button on the control panel for ten seconds.	The TV will turn off and power on. Any changes you made most recently, before using SYSTEM RESET , may be lost.
Reset All	To reset all consumer-accessible settings and all memories to the original factory defaults.	Press MENU and go to Setup > Reset All . CAUTION: All owner-performed setups and adjustments will be erased.	The TV will return to the default condition and will start the guided setup. All memory and settings outlined in this Owner's Guide will need to be set again.

General TV Operation

	Symptom	Remarks
1.	A fan is running even while the TV is powered off.	The room is too warm. When the TV is off, internal components continue to draw power and must be cooled by the fan.
2.	The TV remote control does not work.	<ul style="list-style-type: none"> Check that the batteries are fresh and installed correctly. Be no more than 20 feet from the TV when using the remote control. Reset the remote control. See "Care of the Remote Control," page 29.
3.	When I try to use the remote control, the POWER key blinks five times.	Replace the batteries.
4.	TV does not respond to the remote control or to control-panel buttons and TV will not power on or off.	<ul style="list-style-type: none"> Unplug the AC power cord for 10 seconds. Press and hold the POWER button on the control panel to perform system reset.
5.	When a device is selected from the inputs menu, the screen is blue or black or the screen saver appeared (no signal source).	<ul style="list-style-type: none"> Make sure the selected device is turned on. Begin play of the device.
6.	You cannot access a channel.	<ul style="list-style-type: none"> Use number keys instead of CHANNEL \wedge/\vee. Be sure the channel you want to view is in memory. Check that the TV is switched to the correct device or antenna for that channel by pressing the INPUT key. Make sure the channel is not locked in the Channel Locks menu. If you cannot tune to a virtual digital channel even though the TV has already memorized digital channels, tune to the physical (RF) channel number used by the broadcaster. The virtual channel will then be automatically added to memory. See "Adding a Channel," page 24 for more on RF channels. You may be trying to tune to an analog channel that is no longer broadcasting.
7.	Rating restrictions are not working.	Open the Locks menu and: <ul style="list-style-type: none"> Verify that the ratings locks are active. Rating restrictions apply only to content on the antenna input.

Appendix B: Troubleshooting, continued

TV Power On/Off

	Symptom	Remarks
1.	TV takes an excessively long time to power on.	When powered on, the TV needs time to boot up, just as a computer does. Also, the TV's lamp requires a few moments to heat up to full brightness.
2.	You cannot program the TV to turn on automatically (Timer function)	<ul style="list-style-type: none"> The TV may be locked. The clock may not be set.
3.	TV turned itself off.	<p>Green light on the front panel is blinking</p> <ul style="list-style-type: none"> Momentary power fluctuation caused the TV to turn off to prevent damage. Wait for the green light to stop flashing and turn the TV on again. If the TV does not stay on, press the POWER button on the control panel for at least eight seconds to perform System Reset. If this happens frequently, obtain an AC line power conditioner/surge protector. An unusual digital signal may have been received, triggering a protection circuit. Wait for the light to stop flashing and turn TV on. <p>Amber light on the front panel is lit</p> <ul style="list-style-type: none"> Internal TV temperature has exceeded proper levels. Cool the room. The TV has overheated. Clear blocked air vents and ensure at least four inches of clearance on all sides of the TV.
4.	TV will not power off.	Press the POWER button on the control panel for ten seconds to perform System Reset.

Picture

	Symptom	Remarks
1.	Picture does not look like a high-definition picture.	Not all signals are high-definition signals. To receive high-definition programming from your cable or satellite provider, you must subscribe to the provider's high-definition service. Some over-the-air broadcasts are in high-definition and can be received with a high-quality antenna suited to your location.
2.	TV has sound but no picture.	<ul style="list-style-type: none"> Check that all video inputs are plugged in firmly. Press and hold the POWER button on the control panel for ten seconds to perform System Reset.
3.	Picture has become dimmer.	<ul style="list-style-type: none"> The lamp is nearing the end of its life. Order a new lamp. Adjust picture brightness and contrast to maximum levels.
4.	Picture from an HDMI input is noisy (poor quality).	Upgrade a Category 1 (unmarked) HDMI cable to a high-speed HDMI cable.
5.	The image from a computer appears distorted when viewed on the TV.	<ul style="list-style-type: none"> Normal TV operation. The TV does not correct distortion in the picture from a computer because the correction process may cut off the edges of the image. The picture shape may be wrong for the image. Press FORMAT to change.

Appendix B: Troubleshooting, continued

Sound

	Symptom	Remarks
1.	There is no sound even when the volume is turned up.	<ul style="list-style-type: none"> • Check if the MUTE key is on. • The TV's Sound > Analog Listen To setting may be set to SAP (analog program from the ANT input) but no SAP is being broadcast. • The TV's Sound > Language setting for a digital program may be set to an unavailable language. • Check that the Sound > TV Speaker option is set to ON to hear sound from the TV speakers. • If using an A/V receiver, check that the Sound > TV Speaker option is set to OFF to hear sound from the A/V receiver speakers. • Press and hold the POWER button on the control panel for 10 seconds to perform System Reset.
2.	The sound does not match the screen picture.	The TV's Sound > Analog Listen To setting may be set to SAP (analog program from the antenna input).
3.	The sound from my A/V receiver does not match the screen picture (I should hear the correct audio from my A/V receiver).	<p>Check that DIGITAL AUDIO OUTPUT on TV's main panel is connected to the A/V receiver.</p> <p>Without this connection, devices connected only to the TV (and not the A/V receiver) can be heard only from the TV speakers. Note that this includes the ANT input and any device sending audio to the TV only.</p>

Trademark and License Information

LICENSOR'S SUPPLIERS DO NOT MAKE OR PASS ON TO END USER OR ANY OTHER THIRD PARTY, ANY EXPRESS, IMPLIED OR STATUTORY WARRANTY OR REPRESENTATION ON BEHALF OF SUCH SUPPLIERS, INCLUDING, BUT NOT LIMITED TO THE IMPLIED WARRANTIES OF NON-INFRINGEMENT, TITLE, MERCHANTABILITY OR FITNESS FOR A PARTICULAR PURPOSE.

Digital Light Processing® and DLP® are registered trademarks of Texas Instruments.

Manufactured under license from Dolby Laboratories. Dolby is a trademark of Dolby Laboratories.

ENERGY STAR® and the ENERGY STAR mark are registered U.S. marks. ENERGY STAR is a registered mark owned by the U.S. government.

HDMI®, the HDMI Logo, and High-Definition Multimedia Interface are trademarks or registered trademarks of HDMI Licensing LLC in the United States and other countries.

The software in this TV is based in part on the work of the Independent JPEG Group, copyright © 1991-1998, Thomas G. Lane, all rights reserved.

Mitsubishi TV Software

END-USER LICENSE AGREEMENT FOR EMBEDDED SOFTWARE

IMPORTANT – READ CAREFULLY: This License Agreement is a legal agreement between you (either an individual or an entity) and Mitsubishi Digital Electronics America, Inc. (MDEA) for all software pre installed and/or provided along with this television (“Software”). By utilizing this television and Software, you agree to be bound by the terms of this License Agreement.

The Software is protected by United States copyright laws and international treaty provisions, as well as other intellectual property laws and treaties. The Software is licensed, not sold.

1. **LICENSE GRANT.** MDEA grants you a non-exclusive, non-transferable, limited right and license to use one copy of the Software only with the Mitsubishi television model that included this owner’s guide and owned by you.

2. **RIGHTS AND LIMITATIONS.**

Software Not for Resale. You may not resell or otherwise transfer for value the Software, except in conjunction with a sale of the TV that Software has been pre installed.

Prohibition on Reverse Engineering, Decompilation and Disassembly. The Software contains trade secrets or other proprietary material in its human perceivable form and to protect them, you may not reverse engineer, decompile, or disassemble, or otherwise reduce the Software to any human perceivable form, except to the extent that the foregoing restriction is expressly prohibited by applicable law.

Separation of Components. The Software is licensed as a single product. Its component parts may not be separated for use on more than one TV.

No Rental. You may not rent, lease, lend, or sublicense the Software.

Trademarks. This License Agreement does not grant you any rights to any trademarks of MDEA.

3. **VIOLATIONS.** You understand that any use, copying or transfer of the Software, except as permitted pursuant to this License, may subject you to serious criminal and civil penalties including damages and an award to MDEA of attorneys’ fees in connection with any violation of this License. You further understand that you may be held legally responsible for any copyright infringement or other violation of intellectual property rights that is caused, encouraged, or induced by your failure to abide by the terms of the License. This license is effective until terminated, and will terminate immediately without notice from MDEA or judicial resolution if you fail to comply with any provision of this License.

4. **COPYRIGHT.** All title and intellectual property rights in and to the Software (including but not limited to any images, photographs, animations, video, audio, music, text, and “applets” incorporated into the Software), and any accompanying printed materials are owned by or licensed to MDEA. All title and intellectual property rights in and to the content which may be accessed through use of the Software is the property of the respective content owner and may be protected by applicable copyright or other intellectual property laws and treaties. This License Agreement grants you no rights to use such content, except that you own the media on which the Software is recorded, but MDEA and its licensors retain ownership of the Software itself. All rights not expressly granted are reserved by MDEA.

5. **EXPORT RESTRICTIONS.** MDEA is licensing the Software for use within the United States. You agree that you will not export or re-export the Software. You specifically agree not to export or re-export the Software: (i) to any country to which the U.S. has embargoed or restricted the export of goods or services, which currently include, but are not necessarily limited to Cuba, Iran, Iraq, Libya, North Korea, Sudan, and Syria, or to any national of any such country, wherever located, who intends to transmit or transport the Software back to such country; (ii) to any person or entity who you know or have reason to know will utilize the Software in the design, development, or production of nuclear, chemical, or biological weapons; or (iii) to any person or entity who has been prohibited from participating in U.S. export transactions by any federal agency of the U.S. government. You warrant and represent that neither the BXA nor any other U.S. federal agency has suspended, revoked, or denied your export privileges.

6. **DISCLAIMER OF WARRANTY. EXCEPT AS OTHERWISE PROVIDED IN THIS LICENSE OR IN THE LIMITED WARRANTY APPLICABLE TO THE TV, MDEA MAKES NO OTHER WARRANTIES OF ANY KIND WHATSOEVER REGARDING THE SOFTWARE AND HEREBY EXPRESSLY DISCLAIMS ALL WARRANTIES OF ANY KIND WHATSOEVER, EXPRESS OR IMPLIED, WITH RESPECT TO THE SOFTWARE. ALL IMPLIED WARRANTIES, INCLUDING, WITHOUT LIMITATION, THE IMPLIED WARRANTIES OF MERCHANTABILITY AND FITNESS FOR A PARTICULAR PURPOSE ARE HEREBY EXPRESSLY DISCLAIMED BY MDEA. IN NO EVENT SHALL MDEA BE LIABLE TO YOU OR ANY THIRD PARTIES, IN CONTRACT, IN TORT OR OTHERWISE, FOR ANY DIRECT, INDIRECT, SPECIAL, INCIDENTAL OR CONSEQUENTIAL DAMAGES OF ANY KIND OR NATURE. BECAUSE SOME JURISDICTIONS DO NOT ALLOW THE EXCLUSION OR LIMITATION OF IMPLIED WARRANTIES, THE ABOVE LIMITATION MAY NOT APPLY TO YOU.**

7. **LIMITATION OF LIABILITY. MDEA SHALL NOT, UNDER ANY CIRCUMSTANCES BE LIABLE TO YOU OR ANY THIRD PARTIES FOR ANY DAMAGES OF ANY NATURE, WHETHER INDIRECT, SPECIAL, INCIDENTAL, CONSEQUENTIAL OR OTHERWISE, INCLUDING, BUT NOT LIMITED TO, ANY CLAIMS FOR LOST PROFITS, LOSS OF GOOD WILL OR EXPENDITURES MADE OR COMMITTED FOR IN RELIANCE ON THE CONTINUATION OF THIS LICENSE. YOU AGREE THAT NEITHER MDEA’S BREACH OF THIS LICENSE NOR ITS FAILURE TO REPAIR A DEFECT, ERROR OR BUG SHALL CONSTITUTE A FAILURE OF THE ESSENTIAL PURPOSE OF THIS LICENSE. BECAUSE SOME JURISDICTIONS DO NOT ALLOW THE EXCLUSION OR LIMITATION OF LIABILITY FOR CONSEQUENTIAL OR INCIDENTAL DAMAGES, THE ABOVE LIMITATIONS MAY NOT APPLY TO YOU. MDEA’S liability to you for direct damages for any cause whatsoever and regardless of the form of the action, will be limited to the money paid by you for the TV (based on fair market value of the TV) that caused the damages.**

8. **GENERAL.** This License Agreement will be governed by the laws of the State of California.

WARNING: This product contains chemicals known to the State of California to cause cancer and/or birth defects or other reproductive harm.

For assistance call 1(800) 332-2119

GNU General Public License

Version 2, June 1991

Copyright (C) 1989, 1991

Free Software Foundation, Inc.
675 Mass Ave, Cambridge, MA 02139, USA

Everyone is permitted to copy and distribute verbatim copies of this license document, but changing it is not allowed.

Preamble

The licenses for most software are designed to take away your freedom to share and change it. By contrast, the GNU General Public License is intended to guarantee your freedom to share and change free software--to make sure the software is free for all its users. This General Public License applies to most of the Free Software Foundation's software and to any other program whose authors commit to using it. (Some other Free Software Foundation software is covered by the GNU Library General Public License instead.) You can apply it to your programs, too.

When we speak of free software, we are referring to freedom, not price. Our General Public Licenses are designed to make sure that you have the freedom to distribute copies of free software (and charge for this service if you wish), that you receive source code or can get it if you want it, that you can change the software or use pieces of it in new free programs; and that you know you can do these things.

To protect your rights, we need to make restrictions that forbid anyone to deny you these rights or to ask you to surrender the rights. These restrictions translate to certain responsibilities for you if you distribute copies of the software, or if you modify it.

For example, if you distribute copies of such a program, whether gratis or for a fee, you must give the recipients all the rights that you have. You must make sure that they, too, receive or can get the source code. And you must show them these terms so they know their rights.

We protect your rights with two steps: (1) copyright the software, and (2) offer you this license which gives you legal permission to copy, distribute and/or modify the software.

Also, for each author's protection and ours, we want to make certain that everyone understands that there is no warranty for this free software. If the software is modified by someone else and passed on, we want its recipients to know that what they have is not the original, so that any problems introduced by others will not reflect on the original authors' reputations.

Finally, any free program is threatened constantly by software patents. We wish to avoid the danger that redistributors of a free program will individually obtain patent licenses, in effect making the program proprietary. To prevent this, we have made it clear that any patent must be licensed for everyone's free use or not licensed at all.

The precise terms and conditions for copying, distribution and modification follow.

GNU GENERAL PUBLIC LICENSE TERMS AND CONDITIONS FOR COPYING, DISTRIBUTION AND MODIFICATION

0. This License applies to any program or other work which contains a notice placed by the copyright holder saying it may be distributed under the terms of this General Public License. The "Program", below, refers to any such program or work, and a "work based on the Program" means either the Program or any derivative work under copyright law: that is to say, a work containing the Program or a portion of it, either verbatim or with modifications and/or translated into another language. (Hereinafter, translation is included without limitation in the term "modification".) Each licensee is addressed as "you".

Activities other than copying, distribution and modification are not covered by this License; they are outside its scope. The act of running the Program is not restricted, and the output from the Program is covered only if its contents constitute a work based on the Program (independent of having been made by running the Program). Whether that is true depends on what the Program does.

1. You may copy and distribute verbatim copies of the Program's source code as you receive it, in any medium, provided that you conspicuously and appropriately publish on each copy an appropriate copyright notice and disclaimer of warranty; keep intact all the notices that refer to this License and to the absence of any warranty; and give any other recipients of the Program a copy of this License along with the Program.

You may charge a fee for the physical act of transferring a copy, and you may at your option offer warranty protection in exchange for a fee.

2. You may modify your copy or copies of the Program or any portion of it, thus forming a work based on the Program, and copy and distribute such modifications or work under the terms of Section 1 above, provided that you also meet all of these conditions:

- You must cause the modified files to carry prominent notices stating that you changed the files and the date of any change.
- You must cause any work that you distribute or publish, that in whole or in part contains or is derived from the Program or any part thereof, to be licensed as a whole at no charge to all third parties under the terms of this License.
- If the modified program normally reads commands interactively when run, you must cause it, when started running for such interactive use in the most ordinary way, to print or display an announcement including an appropriate copyright notice and a notice that there is no warranty (or else, saying that you provide a warranty) and that users may redistribute the program under these conditions, and telling the user how to view a copy of this License. (Exception: if the Program itself is interactive but does not normally print such an announcement, your work based on the Program is not required to print an announcement.)

These requirements apply to the modified work as a whole. If identifiable sections of that work are not derived from the Program, and can be reasonably considered independent and separate works in themselves, then this License, and its terms, do not apply to those sections when you distribute them as separate works. But when you distribute the same sections as part of a whole which is a work based on the Program, the distribution of the whole must be on the terms of this License, whose permissions for other licensees extend to the entire whole, and thus to each and every part regardless of who wrote it.

Thus, it is not the intent of this section to claim rights or contest your rights to work written entirely by you; rather, the intent is to exercise the right to control the distribution of derivative or collective works based on the Program.

In addition, mere aggregation of another work not based on the Program with the Program (or with a work based on the Program) on a volume of a storage or distribution medium does not bring the other work under the scope of this License.

3. You may copy and distribute the Program (or a work based on it, under Section 2) in object code or executable form under the terms of Sections 1 and 2 above provided that you also do one of the following:

- Accompany it with the complete corresponding machine-readable source code, which must be distributed under the terms of Sections 1 and 2 above on a medium customarily used for software interchange; or,
- Accompany it with a written offer, valid for at least three years, to give any third party, for a charge no more than your cost of physically performing source distribution, a complete machine-readable copy of the corresponding source code, to be distributed under the terms of Sections 1 and 2 above on a medium customarily used for software interchange; or,
- Accompany it with the information you received as to the offer to distribute corresponding source code. (This alternative is allowed only for noncommercial distribution and only if you received the program in object code or executable form with such an offer, in accord with Subsection b above.)

The source code for a work means the preferred form of the work for making modifications to it. For an executable work, complete source code means all the source code for all modules it contains, plus any associated interface definition files, plus the scripts used to control compilation and installation of the executable. However, as a special exception, the source code distributed need not include anything that is normally distributed (in either source or binary form) with the major components (compiler, kernel, and so on) of the operating system on which the executable runs, unless that component itself accompanies the executable.

If distribution of executable or object code is made by offering access to copy from a designated place, then offering equivalent access to copy the source code from the same place counts as distribution of the source code, even though third parties are not compelled to copy the source along with the object code.

4. You may not copy, modify, sublicense, or distribute the Program except as expressly provided under this License. Any attempt otherwise to copy, modify, sublicense or distribute the Program is void, and will automatically terminate your rights under this License. However, parties who have received copies, or rights, from you under this License will not have their licenses terminated so long as such parties remain in full compliance.

5. You are not required to accept this License, since you have not signed it. However, nothing else grants you permission to modify or distribute the Program or its derivative works. These actions are prohibited by law if you do not accept this License. Therefore, by modifying or distributing the Program (or any work based on the Program), you indicate your acceptance of this License to do so, and all its terms and conditions for copying, distributing or modifying the Program or works based on it.

6. Each time you redistribute the Program (or any work based on the Program), the recipient automatically receives a license from the original licensor to copy, distribute or modify the Program subject to these terms and conditions. You may not impose any further restrictions on the recipients' exercise of the rights granted herein. You are not responsible for enforcing compliance by third parties to this License.

7. If, as a consequence of a court judgment or allegation of patent infringement or for any other reason (not limited to patent issues), conditions are imposed on you (whether by court order, agreement or otherwise) that contradict the conditions of this License, they do not excuse you from the conditions of this License. If you cannot distribute so as to satisfy simultaneously your obligations under this License and any other pertinent obligations, then as a consequence you may not distribute the Program at all. For example, if a patent license would not permit royalty-free redistribution of the Program by all those who receive copies directly or indirectly through you, then the only way you could satisfy both it and this License would be to refrain entirely from distribution of the Program.

If any portion of this section is held invalid or unenforceable under any particular circumstance, the balance of the section is intended to apply and the section as a whole is intended to apply in other circumstances.

It is not the purpose of this section to induce you to infringe any patents or other property right claims or to contest validity of any such claims; this section has the sole purpose of protecting the integrity of the free software distribution system, which is implemented by public license practices. Many people have made generous contributions to the wide range of software distributed through that system in reliance on consistent application of that system; it is up to the author/donor to decide if he or she is willing to distribute software through any other system and a licensee cannot impose that choice.

This section is intended to make thoroughly clear what is believed to be a consequence of the rest of this License.

8. If the distribution and/or use of the Program is restricted in certain countries either by patents or by copyrighted interfaces, the original copyright holder who places the Program under this License may add an explicit geographical distribution limitation excluding those countries, so that distribution is permitted only in or among countries not thus excluded. In such case, this License incorporates the limitation as if written in the body of this License.

9. The Free Software Foundation may publish revised and/or new versions of the General Public License from time to time. Such new versions will be similar in spirit to the present version, but may differ in detail to address new problems or concerns.

Each version is given a distinguishing version number. If the Program specifies a version number of this License which applies to it and "any later version", you have the option of following the terms and conditions either of that version or of any later version published by the Free Software Foundation. If the Program does not specify a version number of this License, you may choose any version ever published by the Free Software Foundation.

If you are interested in obtaining open source code for this product, please contact Mitsubishi at (800) 332-2119. A nominal handling and mailing charge may apply.

For assistance call 1(800) 332-2119

10. If you wish to incorporate parts of the Program into other free programs whose distribution conditions are different, write to the author to ask for permission. For software which is copyrighted by the Free Software Foundation, write to the Free Software Foundation; we sometimes make exceptions for this. Our decision will be guided by the two goals of preserving the free status of all derivatives of our free software and of promoting the sharing and reuse of software generally.

NO WARRANTY

11. BECAUSE THE PROGRAM IS LICENSED FREE OF CHARGE, THERE IS NO WARRANTY FOR THE PROGRAM, TO THE EXTENT PERMITTED BY APPLICABLE LAW. EXCEPT WHEN OTHERWISE STATED IN WRITING THE COPYRIGHT HOLDERS AND/OR OTHER PARTIES PROVIDE THE PROGRAM "AS IS" WITHOUT WARRANTY OF ANY KIND, EITHER EXPRESSED OR IMPLIED, INCLUDING, BUT NOT LIMITED TO, THE IMPLIED WARRANTIES OF MERCHANTABILITY AND FITNESS FOR A PARTICULAR PURPOSE. THE ENTIRE RISK AS TO THE QUALITY AND PERFORMANCE OF THE PROGRAM IS WITH YOU. SHOULD THE PROGRAM PROVE DEFECTIVE, YOU ASSUME THE COST OF ALL NECESSARY SERVICING, REPAIR OR CORRECTION.

12. IN NO EVENT UNLESS REQUIRED BY APPLICABLE LAW OR AGREED TO IN WRITING WILL ANY COPYRIGHT HOLDER, OR ANY OTHER PARTY WHO MAY MODIFY AND/OR REDISTRIBUTE THE PROGRAM AS PERMITTED ABOVE, BE LIABLE TO YOU FOR DAMAGES, INCLUDING ANY GENERAL, SPECIAL, INCIDENTAL OR CONSEQUENTIAL DAMAGES ARISING OUT OF THE USE OR INABILITY TO USE THE PROGRAM (INCLUDING BUT NOT LIMITED TO LOSS OF DATA OR DATA BEING RENDERED INACCURATE OR LOSSES SUSTAINED BY YOU OR THIRD PARTIES OR A FAILURE OF THE PROGRAM TO OPERATE WITH ANY OTHER PROGRAMS), EVEN IF SUCH HOLDER OR OTHER PARTY HAS BEEN ADVISED OF THE POSSIBILITY OF SUCH DAMAGES.

GNU GENERAL PUBLIC LICENSE

Version 3, 29 June 2007

Copyright © 2007 Free Software Foundation, Inc. <<http://fsf.org/>>

Everyone is permitted to copy and distribute verbatim copies of this license document, but changing it is not allowed.

Preamble

The GNU General Public License is a free, copyleft license for software and other kinds of works.

The licenses for most software and other practical works are designed to take away your freedom to share and change the works. By contrast, the GNU General Public License is intended to guarantee your freedom to share and change all versions of a program--to make sure it remains free software for all its users. We, the Free Software Foundation, use the GNU General Public License for most of our software; it applies also to any other work released this way by its authors. You can apply it to your programs, too.

When we speak of free software, we are referring to freedom, not price. Our General Public Licenses are designed to make sure that you have the freedom to distribute copies of free software (and charge for them if you wish), that you receive source code or can get it if you want it, that you can change the software or use pieces of it in new free programs, and that you know you can do these things.

To protect your rights, we need to prevent others from denying you these rights or asking you to surrender the rights. Therefore, you have certain responsibilities if you distribute copies of the software, or if you modify it: responsibilities to respect the freedom of others.

For example, if you distribute copies of such a program, whether gratis or for a fee, you must pass on to the recipients the same freedoms that you received. You must make sure that they, too, receive or can get the source code. And you must show them these terms so they know their rights.

Developers that use the GNU GPL protect your rights with two steps: (1) assert copyright on the software, and (2) offer you this License giving you legal permission to copy, distribute and/or modify it.

For the developers' and authors' protection, the GPL clearly explains that there is no warranty for this free software. For both users' and authors' sake, the GPL requires that modified versions be marked as changed, so that their problems will not be attributed erroneously to authors of previous versions.

Some devices are designed to deny users access to install or run modified versions of the software inside them, although the manufacturer can do so. This is fundamentally incompatible with the aim of protecting users' freedom to change the software. The systematic pattern of such abuse occurs in the area of products for individuals to use, which is precisely where it is most unacceptable. Therefore, we have designed this version of the GPL to prohibit the practice for those products. If such problems arise substantially in other domains, we stand ready to extend this provision to those domains in future versions of the GPL, as needed to protect the freedom of users. Finally, every program is threatened constantly by software patents. States should not allow patents to restrict development and use of software on general-purpose computers, but in those that do, we wish to avoid the special danger that patents applied to a free program could make it effectively proprietary. To prevent this, the GPL assures that patents cannot be used to render the program non-free.

The precise terms and conditions for copying, distribution and modification follow.

TERMS AND CONDITIONS

0. Definitions.

"This License" refers to version 3 of the GNU General Public License.

"Copyright" also means copyright-like laws that apply to other kinds of works, such as semiconductor masks.

"The Program" refers to any copyrightable work licensed under this License. Each licensee is addressed as "you". "Licenseses" and "recipients" may be individuals or organizations.

To "modify" a work means to copy from or adapt all or part of the work in a fashion requiring copyright permission, other than the making of an exact copy. The resulting work is called a "modified version" of the earlier work or a work "based on" the earlier work.

A "covered work" means either the unmodified Program or a work based on the Program.

To "propagate" a work means to do anything with it that, without permission, would make you directly or secondarily liable for infringement under applicable copyright law, except executing it on a computer or modifying a private copy. Propagation includes copying, distribution (with or without modification), making available to the public, and in some countries other activities as well.

To "convey" a work means any kind of propagation that enables other parties to make or receive copies. Mere interaction with a user through a computer network, with no transfer of a copy, is not conveying.

An interactive user interface displays "Appropriate Legal Notices" to the extent that it includes a convenient and prominently visible feature that (1) displays an appropriate copyright notice, and (2) tells the user that there is no warranty for the work (except to the extent that warranties are provided), that licensees may convey the work under this License, and how to view a copy of this License. If the interface presents a list of user commands or options, such as a menu, a prominent item in the list meets this criterion.

1. Source Code.

The "source code" for a work means the preferred form of the work for making modifications to it. "Object code" means any non-source form of a work.

A "Standard Interface" means an interface that either is an official standard defined by a recognized standards body, or, in the case of interfaces specified for a particular programming language, one that is widely used among developers working in that language.

The "System Libraries" of an executable work include anything, other than the work as a whole, that (a) is included in the normal form of packaging a Major Component, but which is not part of that Major Component, and (b) serves only to enable use of the work with that Major Component, or to implement a Standard Interface for which an implementation is available to the public in source code form. A "Major Component", in this context, means a major essential component (kernel, window system, and so on) of the specific operating system (if any) on which the executable work runs, or a compiler used to produce the work, or an object code interpreter used to run it.

The "Corresponding Source" for a work in object code form means all the source code needed to generate, install, and (for an executable work) run the object code and to modify the work, including scripts to control those activities. However, it does not include the work's System Libraries, or general-purpose tools or generally available free programs which are used unmodified in performing those activities but which are not part of the work. For example, Corresponding Source includes interface definition files associated with source files for the work, and the source code for shared libraries and dynamically linked subprograms that the work is specifically designed to require, such as by intimate data communication or control flow between those subprograms and other parts of the work.

The Corresponding Source need not include anything that users can regenerate automatically from other parts of the Corresponding Source.

The Corresponding Source for a work in source code form is that same work.

2. Basic Permissions.

All rights granted under this License are granted for the term of copyright on the Program, and are irrevocable provided the stated conditions are met. This License explicitly affirms your unlimited permission to run the unmodified Program. The output from running a covered work is covered by this License only if the output, given its content, constitutes a covered work. This License acknowledges your rights of fair use or other equivalent, as provided by copyright law.

You may make, run and propagate covered works that you do not convey, without conditions so long as your license otherwise remains in force. You may convey covered works to others for the sole purpose of having them make modifications exclusively for you, or provide you with facilities for running those works, provided that you comply with the terms of this License in conveying all material for which you do not control copyright. Those thus making or running the covered works for you must do so exclusively on your behalf, under your direction and control, on terms that prohibit them from making any copies of your copyrighted material outside their relationship with you.

Conveying under any other circumstances is permitted solely under the conditions stated below. Sublicensing is not allowed; section 10 makes it unnecessary.

3. Protecting Users' Legal Rights From Anti-Circumvention Law.

No covered work shall be deemed part of an effective technological measure under any applicable law fulfilling obligations under article 11 of the WIPO copyright treaty adopted on 20 December 1996, or similar laws prohibiting or restricting circumvention of such measures.

When you convey a covered work, you waive any legal power to forbid circumvention of technological measures to the extent such circumvention is effected by exercising rights under this License with respect to the covered work, and you disclaim any intention to limit operation or modification of the work as a means of enforcing, against the work's users, your or third parties' legal rights to forbid circumvention of technological measures.

4. Conveying Verbatim Copies.

You may convey verbatim copies of the Program's source code as you receive it, in any medium, provided that you conspicuously and appropriately publish on each copy an appropriate copyright notice; keep intact all notices stating that this License and any non-permissive terms added in accord with section 7 apply to the code; keep intact all notices of the absence of any warranty; and give all recipients a copy of this License along with the Program.

You may charge any price or no price for each copy that you convey, and you may offer support or warranty protection for a fee.

5. Conveying Modified Source Versions.

You may convey a work based on the Program, or the modifications to produce it from the Program, in the form of source code under the terms of section 4, provided that you also meet all of these conditions:

- The work must carry prominent notices stating that you modified it, and giving a relevant date.
- The work must carry prominent notices stating that it is released under this License and any conditions added under section 7. This requirement modifies the requirement in section 4 to "keep intact all notices".
- You must license the entire work, as a whole, under this License to anyone who comes into possession of a copy. This License will therefore apply, along with any applicable section 7 additional terms, to the whole of the work, and all its parts, regardless of how they are packaged. This License gives no permission to license the work in any other way, but it does not invalidate such permission if you have separately received it.
- If the work has interactive user interfaces, each must display Appropriate Legal Notices; however, if the Program has interactive interfaces that do not display Appropriate Legal Notices, your work need not make them do so. A compilation of a covered work with other separate and independent works, which are not by their nature extensions of the covered work, and which are not combined with it such as to form a larger program, in or on a volume of a storage or distribution medium, is called an "aggregate" if the compilation and its resulting copyright are not used to limit the access or legal rights of the compilation's users beyond what the individual works permit. Inclusion of a covered work in an aggregate does not cause this License to apply to the other parts of the aggregate.

6. Conveying Non-Source Forms.

You may convey a covered work in object code form under the terms of sections 4 and 5, provided that you also convey the machine-readable Corresponding Source under the terms of this License, in one of these ways:

- Convey the object code in, or embodied in, a physical product (including a physical distribution medium), accompanied by the Corresponding Source fixed on a durable physical medium customarily used for software interchange.
- Convey the object code in, or embodied in, a physical product (including a physical distribution medium), accompanied by a written offer, valid for at least three years and valid for as long as you offer spare parts or customer support for that product model, to give anyone who possesses the object code either (1) a copy of the Corresponding Source for all the software in the product that is covered by this License, on a durable physical medium customarily used for software interchange, for a price no more than your reasonable cost of physically performing this conveying of source, or (2) access to copy the Corresponding Source from a network server at no charge.
- Convey individual copies of the object code with a copy of the written offer to provide the Corresponding Source. This alternative is allowed only occasionally and noncommercially, and only if you received the object code with such an offer, in accord with subsection 6b.
- Convey the object code by offering access from a designated place (gratis or for a charge), and offer equivalent access to the Corresponding Source in the same way through the same place at no further charge. You need not require recipients to copy the Corresponding Source along with the object code. If the place to copy the object code is a network server, the Corresponding Source may be on a different server (operated by you or a third party) that supports equivalent copying facilities, provided you maintain clear directions next to the object code saying where to find the Corresponding Source. Regardless of what server hosts the Corresponding Source, you remain obligated to ensure that it is available for as long as needed to satisfy these requirements.
- Convey the object code using peer-to-peer transmission, provided you inform other peers where the object code and Corresponding Source of the work are being offered to the general public at no charge under subsection

For assistance call 1(800) 332-2119

6d.

A separable portion of the object code, whose source code is excluded from the Corresponding Source as a System Library, need not be included in conveying the object code work.

A "User Product" is either (1) a "consumer product", which means any tangible personal property which is normally used for personal, family, or household purposes, or (2) anything designed or sold for incorporation into a dwelling. In determining whether a product is a consumer product, doubtful cases shall be resolved in favor of coverage. For a particular product received by a particular user, "normally used" refers to a typical or common use of that class of product, regardless of the status of the particular user or of the way in which the particular user actually uses, or expects or is expected to use, the product. A product is a consumer product regardless of whether the product has substantial commercial, industrial or non-consumer uses, unless such uses represent the only significant mode of use of the product.

"Installation Information" for a User Product means any methods, procedures, authorization keys, or other information required to install and execute modified versions of a covered work in that User Product from a modified version of its Corresponding Source. The information must suffice to ensure that the continued functioning of the modified object code is in no case prevented or interfered with solely because modification has been made. If you convey an object code work under this section in, or with, or specifically for use in, a User Product, and the conveying occurs as part of a transaction in which the right of possession and use of the User Product is transferred to the recipient in perpetuity or for a fixed term (regardless of how the transaction is characterized), the Corresponding Source conveyed under this section must be accompanied by the Installation Information. But this requirement does not apply if neither you nor any third party retains the ability to install modified object code on the User Product (for example, the work has been installed in ROM).

The requirement to provide Installation Information does not include a requirement to continue to provide support service, warranty, or updates for a work that has been modified or installed by the recipient, or for the User Product in which it has been modified or installed. Access to a network may be denied when the modification itself materially and adversely affects the operation of the network or violates the rules and protocols for communication across the network.

Corresponding Source conveyed, and Installation Information provided, in accord with this section must be in a format that is publicly documented (and with an implementation available to the public in source code form), and must require no special password or key for unpacking, reading or copying.

7. Additional Terms.

"Additional permissions" are terms that supplement the terms of this License by making exceptions from one or more of its conditions. Additional permissions that are applicable to the entire Program shall be treated as though they were included in this License, to the extent that they are valid under applicable law. If additional permissions apply only to part of the Program, that part may be used separately under those permissions, but the entire Program remains governed by this License without regard to the additional permissions.

When you convey a copy of a covered work, you may at your option remove any additional permissions from that copy, or from any part of it. (Additional permissions may be written to require their own removal in certain cases when you modify the work.) You may place additional permissions on material, added by you to a covered work, for which you have or can give appropriate copyright permission.

Notwithstanding any other provision of this License, for material you add to a covered work, you may (if authorized by the copyright holders of that material) supplement the terms of this License with terms:

- Disclaiming warranty or limiting liability differently from the terms of sections 15 and 16 of this License; or
- Requiring preservation of specified reasonable legal notices or author attributions in that material or in the Appropriate Legal Notices displayed by works containing it; or
- Prohibiting misrepresentation of the origin of that material, or requiring that modified versions of such material be marked in reasonable ways as different from the original version; or
- Limiting the use for publicity purposes of names of licensors or authors of the material; or
- Declining to grant rights under trademark law for use of some trade names, trademarks, or service marks; or
- Requiring indemnification of licensors and authors of that material (or modified versions of it) with contractual assumptions of liability to the recipient, for any liability that these contractual assumptions directly impose on those licensors and authors.

All other non-permissive additional terms are considered "further restrictions" within the meaning of section 10. If the Program as you received it, or any part of it, contains a notice stating that it is governed by this License along with a term that is a further restriction, you may remove that term. If a license document contains a further restriction but permits relicensing or conveying under this License, you may add to a covered work material governed by the terms of that license document, provided that the further restriction does not survive such relicensing or conveying.

If you add terms to a covered work in accord with this section, you must place, in the relevant source files, a statement of the additional terms that apply to those files, or a notice indicating where to find the applicable terms.

Additional terms, permissive or non-permissive, may be stated in the form of a separately written license, or stated as exceptions; the above requirements apply either way.

8. Termination.

You may not propagate or modify a covered work except as expressly provided under this License. Any attempt otherwise to propagate or modify it is void, and will automatically terminate your rights under this License (including any patent licenses granted under the third paragraph of section 11).

However, if you cease all violation of this License, then your license from a particular copyright holder is reinstated (a) provisionally, unless and until the copyright holder explicitly and finally terminates your license, and (b) permanently, if the copyright holder fails to notify you of the violation by some reasonable means prior to 60 days after the cessation.

Moreover, your license from a particular copyright holder is reinstated permanently if the copyright holder notifies you of the violation by some reasonable means, this is the first time you have received notice of violation of this License (for any work) from that copyright holder, and you cure the violation prior to 30 days after your receipt of the notice.

Termination of your rights under this section does not terminate the licenses of parties who have received copies or rights from you under this License. If your rights have been terminated and not permanently reinstated, you do not qualify to receive new licenses for the same material under section 10.

9. Acceptance Not Required for Having Copies.

You are not required to accept this License in order to receive or run a copy of the Program. Ancillary propagation of a covered work occurring solely as a consequence of using peer-to-peer transmission to receive a copy likewise does not require acceptance. However, nothing other than this License grants you permission to propagate or modify any covered work. These actions infringe copyright if you do not accept this License. Therefore, by modifying or propagating a covered work, you indicate your acceptance of this License to do so.

10. Automatic Licensing of Downstream Recipients.

Each time you convey a covered work, the recipient automatically receives a license from the original licensors, to run, modify and propagate that work, subject to this License. You are not responsible for enforcing compliance by third parties with this License.

An "entity transaction" is a transaction transferring control of an organization, or substantially all assets of one, or subdividing an organization, or merging organizations. If propagation of a covered work results from an entity transaction, each party to that transaction who receives a copy of the work also receives whatever licenses to the work the party's predecessor in interest had or could give under the previous paragraph, plus a right to possession of the Corresponding Source of the work from the predecessor in interest, if the predecessor has it or can get it with reasonable efforts.

You may not impose any further restrictions on the exercise of the rights granted or affirmed under this License. For example, you may not impose a license fee, royalty, or other charge for exercise of rights granted under this License, and you may not initiate litigation (including a cross-claim or counterclaim in a lawsuit) alleging that any patent claim is infringed by making, using, selling, offering for sale, or importing the Program or any portion of it.

11. Patents.

A "contributor" is a copyright holder who authorizes use under this License of the Program or a work on which the Program is based. The work thus licensed is called the contributor's "contributor version".

A contributor's "essential patent claims" are all patent claims owned or controlled by the contributor, whether already acquired or hereafter acquired, that would be infringed by some manner, permitted by this License, of making, using, or selling its contributor version, but do not include claims that would be infringed only as a consequence of further modification of the contributor version. For purposes of this definition, "control" includes the right to grant patent sublicenses in a manner consistent with the requirements of this License.

Each contributor grants you a non-exclusive, worldwide, royalty-free patent license under the contributor's essential patent claims, to make, use, sell, offer for sale, import and otherwise run, modify and propagate the contents of its contributor version.

In the following three paragraphs, a "patent license" is any express agreement or commitment, however denominated, not to enforce a patent (such as an express permission to practice a patent or covenant not to sue for patent infringement). To "grant" such a patent license to a party means to make such an agreement or commitment not to enforce a patent against the party.

If you convey a covered work, knowingly relying on a patent license, and the Corresponding Source of the work is not available for anyone to copy, free of charge and under the terms of this License, through a publicly available network server or other readily accessible means, then you must either (1) cause the Corresponding Source to be so available, or (2) arrange to deprive yourself of the benefit of the patent license for this particular work, or (3) arrange, in a manner consistent with the requirements of this License, to extend the patent license to downstream recipients. "Knowingly relying" means you have actual knowledge that, but for the patent license, your conveying the covered work in a country, or your recipient's use of the covered work in a country, would infringe one or more identifiable patents in that country that you have reason to believe are valid.

If, pursuant to or in connection with a single transaction or arrangement, you convey, or propagate by procuring conveyance of, a covered work, and grant a patent license to some of the parties receiving the covered work authorizing them to use, propagate, modify or convey a specific copy of the covered work, then the patent license you grant is automatically extended to all recipients of the covered work and works based on it.

A patent license is "discriminatory" if it does not include within the scope of its coverage, prohibits the exercise of, or is conditioned on the non-exercise of one or more of the rights that are specifically granted under this License. You may not convey a covered work if you are a party to an arrangement with a third party that is in the business of distributing software, under which you make payment to the third party based on the extent of your activity of conveying the work, and under which the third party grants, to any of the parties who would receive the covered work from you, a discriminatory patent license (a) in connection with copies of the covered work conveyed by you (or copies made from those copies), or (b) primarily for and in connection with specific products or compilations that contain the covered work, unless you entered into that arrangement, or that patent license was granted, prior to 28 March 2007.

Nothing in this License shall be construed as excluding or limiting any implied license or other defenses to infringement that may otherwise be available to you under applicable patent law.

12. No Surrender of Others' Freedom.

If conditions are imposed on you (whether by court order, agreement or otherwise) that contradict the conditions of this License, they do not excuse you from the conditions of this License. If you cannot convey a covered work so as to satisfy simultaneously your obligations under this License and any other pertinent obligations, then as a consequence you may not convey it at all. For example, if you agree to terms that obligate you to collect a royalty for further conveying from those to whom you convey the Program, the only way you could satisfy both those terms and this License would be to refrain entirely from conveying the Program.

13. Use with the GNU Affero General Public License.

Notwithstanding any other provision of this License, you have permission to link or combine any covered work with a work licensed under version 3 of the GNU Affero General Public License into a single combined work, and to convey the resulting work. The terms of this License will continue to apply to the part which is the covered work, but the special requirements of the GNU Affero General Public License, section 13, concerning interaction through a network will apply to the combination as such.

14. Revised Versions of this License.

The Free Software Foundation may publish revised and/or new versions of the GNU General Public License from time to time. Such new versions will be similar in spirit to the present version, but may differ in detail to address new problems or concerns.

Each version is given a distinguishing version number. If the Program specifies that a certain numbered version of the GNU General Public License "or any later version" applies to it, you have the option of following the terms and conditions either of that numbered version or of any later version published by the Free Software Foundation. If the Program does not specify a version number of the GNU General Public License, you may choose any version ever published by the Free Software Foundation.

If the Program specifies that a proxy can decide which future versions of the GNU General Public License can be used, that proxy's public statement of acceptance of a version permanently authorizes you to choose that version for the Program.

Later license versions may give you additional or different permissions. However, no additional obligations are imposed on any author or copyright holder as a result of your choosing to follow a later version.

15. Disclaimer of Warranty.

THERE IS NO WARRANTY FOR THE PROGRAM, TO THE EXTENT PERMITTED BY APPLICABLE LAW. EXCEPT WHEN OTHERWISE STATED IN WRITING THE COPYRIGHT HOLDERS AND/OR OTHER PARTIES PROVIDE THE PROGRAM "AS IS" WITHOUT WARRANTY OF ANY KIND, EITHER EXPRESSED OR IMPLIED, INCLUDING, BUT NOT LIMITED TO, THE IMPLIED WARRANTIES OF MERCHANTABILITY AND FITNESS FOR A PARTICULAR PURPOSE. THE ENTIRE RISK AS TO THE QUALITY AND PERFORMANCE OF THE PROGRAM IS WITH YOU. SHOULD THE PROGRAM PROVE DEFECTIVE, YOU ASSUME THE COST OF ALL NECESSARY SERVICING, REPAIR OR CORRECTION.

16. Limitation of Liability.

IN NO EVENT UNLESS REQUIRED BY APPLICABLE LAW OR AGREED TO IN WRITING WILL ANY COPYRIGHT HOLDER, OR ANY OTHER PARTY WHO MODIFIES AND/OR CONVEYS THE PROGRAM AS PERMITTED ABOVE, BE LIABLE TO YOU FOR DAMAGES, INCLUDING ANY GENERAL, SPECIAL, INCIDENTAL OR CONSEQUENTIAL DAMAGES ARISING OUT OF THE USE OR INABILITY TO USE THE PROGRAM (INCLUDING BUT NOT LIMITED TO LOSS OF DATA OR DATA BEING RENDERED INACCURATE OR LOSSES SUSTAINED BY YOU OR THIRD PARTIES OR A FAILURE OF THE PROGRAM TO OPERATE WITH ANY OTHER PROGRAMS), EVEN IF SUCH HOLDER OR OTHER PARTY HAS BEEN ADVISED OF THE POSSIBILITY OF SUCH DAMAGES.

17. Interpretation of Sections 15 and 16.

If the disclaimer of warranty and limitation of liability provided above cannot be given local legal effect according to their terms, reviewing courts shall apply local law that most closely approximates an absolute waiver of all civil liability in connection with the Program, unless a warranty or assumption of liability accompanies a copy of the Program in return for a fee.

Mitsubishi Home-Theater Television Limited Warranty

MITSUBISHI DIGITAL ELECTRONICS AMERICA, INC. (“MDEA”) warrants as follows to the original purchaser of this television from an authorized MITSUBISHI Audio/Video Dealer, should it prove defective by reason of against defects arising from improper workmanship and/or material:

a. Parts. The lenticular (i.e. front picture) screen is warranted against defects in materials and workmanship for a period of thirty (30) days from the date of the original purchase at retail. The lamp and all other parts (except any software incorporated into this television) are warranted for a period of one (1) year from the date of the original purchase at retail. We will repair or replace, at our option, any defective part without charge for the part. Parts used for replacement may be replaced with those of like kind and quality and may be new or remanufactured. Parts used for replacement are warranted for the remainder of the original warranty period.

b. Embedded Software. MDEA warrants that all software incorporated into this television set (the “Embedded Software”) will perform in accordance with the functional description of Embedded Software in all material respects, but MDEA does not warrant that the Embedded Software is error-free. The limited warranty contained in this section shall continue for a period of one (1) year from the date of the original purchase at retail. If, after prompt notice within the warranty period, MDEA determines that the Embedded Software has failed to perform in accordance with such functional description in all material respects and if such failure is not due to accident, misuse, modification or misapplication of the Embedded Software, then MDEA shall modify or replace the nonconforming Embedded Software at no charge to you, which at MDEA’s sole discretion may be fulfilled by means of modification or replacement software contained on a replacement memory card for Customer installation. The foregoing shall be MDEA’s sole obligation to you under this limited warranty. All rights under this limited warranty on the Embedded Software also subject to your acceptance of and compliance with the terms of the Software License Agreement applicable to this television, and this limited warranty on the Embedded Software shall be null and void if the Embedded Software is modified or changed in any manner except as specifically authorized by MDEA.

c. Labor. For thirty (30) days after the original purchase at retail, we will repair or replace, at our option, the lenticular screen if it proves defective. For certain items that are designed to be replaced by the consumer, including (but not limited to) some Embedded Software, the consumer is solely responsible for any replacement labor. For all other parts, we will provide the labor for a warranty repair by an authorized MITSUBISHI service center without charge for one (1) year from the original date of purchase at retail.

d. Notice. To obtain warranty service, you must notify an authorized MITSUBISHI service center of any defect within the applicable warranty time period.

e. This DLP Projection Television uses a single DLP chip to create the screen image. This technology creates the image using small dots, or picture elements (pixels). Your DLP Projection TV is manufactured to a high level of performance and quality, in fact, 99.99% perfect in the number of properly functioning pixels. As in other display technology, sometimes a pixel is continuously active, inactive or the incorrect color. Our standard is clear; MDEA warrants only that the percentage of properly functioning pixels will be not less than 99.99% of all pixels.

BEFORE REQUESTING SERVICE, please review the instruction booklet to insure proper installation and correct customer control adjustment. If the problem persists please arrange for warranty service.

1. TO OBTAIN WARRANTY SERVICE:

a. Contact your nearest authorized MITSUBISHI service center, whose name and address can be obtained from your MITSUBISHI dealer, by writing at the address provided below, calling MDEA at the 800-332-2119, or by using the support feature of our website at www.Mitsubishi-tv.com.

b. Warranty service will be provided in your home or, if required, at an authorized service shop, provided that your television is located within the geographic territory customarily covered by an authorized MITSUBISHI service center. If not, you must either deliver your television to an authorized service location at your own expense, or pay for any travel and/or transportation costs the service center may charge to and from your home. Actual service labor will be provided without charge.

c. Proof of purchase date from an authorized MITSUBISHI dealer is required when requesting warranty service. Present your sales receipt or other document which establishes proof and date of purchase. THE RETURN OF THE OWNER REGISTRATION CARD IS NOT A CONDITION OF COVERAGE UNDER THIS LIMITED WARRANTY. However, please return the Owner Registration Card so that we can contact you should a question of safety arise which could affect you.

For assistance call 1(800) 332-2119

d. To obtain a replacement lamp, order the lamp directly from the MDEA Parts Department at (800) 553-7278.

2. THIS LIMITED WARRANTY DOES NOT COVER:

a. Up to .01% pixel outages (small dot picture elements that are dark or incorrectly illuminated).

b. Damage to the lenticular screen or Fresnel lens, screen frame, cosmetic damage or to any other damage where such damage is caused by unauthorized modification, alteration, repairs to or service of the product by anyone other than an authorized MITSUBISHI service center; physical abuse to or misuse of the product (including any failure to carry out any maintenance as described in the Owner's Guide including air vent cleaning or any product damaged by excessive physical or electrical stress); any products that have had a serial number or any part thereof altered, defaced or removed; product use in any manner contrary to the Owner's Guide; freight damage; or any damage caused by acts of God or other factors beyond the reasonable control of MDEA, such as power surge damage caused by electrical system or lightning. This limited warranty also excludes service calls where no defect in the product covered under this warranty is found, service calls related to unsatisfactory audio or visual reception or signal unless caused by a defect in the product that is covered under this limited warranty, all costs, expenses or any other damages arising from product installation, or set-ups, any adjustments of user controls (including contrast, brightness, color, tint, fine tuning, sharpness), other adjustment necessary to prepare the unit for display or use, connection with any external audio receiver, antenna, cable or satellite systems, or service of products purchased or serviced outside the U.S.A. Please consult the operating instructions contained in the Owner's Guide furnished with the product for information regarding user controls.

3. ANY EXPRESS WARRANTY NOT PROVIDED HEREIN, AND ANY REMEDY WHICH, BUT FOR THIS PROVISION, MIGHT ARISE BY IMPLICATION OR OPERATION OF LAW, IS HEREBY EXCLUDED AND DISCLAIMED. THE IMPLIED WARRANTIES OF MERCHANTABILITY AND OF FITNESS FOR ANY PARTICULAR PURPOSE ARE EXPRESSLY LIMITED TO A TERM OF ONE YEAR.

4. UNDER NO CIRCUMSTANCES SHALL MDEA BE LIABLE TO PURCHASER OR ANY OTHER PERSON FOR ANY INCIDENTAL, SPECIAL OR CONSEQUENTIAL DAMAGES, WHETHER ARISING OUT OF BREACH OF WARRANTY, BREACH OF CONTRACT, OR OTHERWISE.

5. Some states do not allow limitations on how long an implied warranty lasts, or the exclusion or limitation of incidental, special, or consequential damages, so the above limitations or exclusions may not apply to you.

6. This limited warranty gives you specific legal rights, and you may also have other rights which vary from state to state.

7. In the event of any dispute under this limited warranty, jurisdiction and venue for resolving that dispute will be in the state where the television was purchased and the laws of such state will govern.



MITSUBISHI DIGITAL ELECTRONICS AMERICA, INC.
9351 Jeronimo Road
Irvine, CA 92618-1904



Website:
www.mitsubishi-tv.com

E-mail:
MDEAservice@mdea.com

Call Consumer Relations for operational or connection assistance at

800-332-2119

**To order replacement or additional
remote controls or lamp cartridges**

Visit our website www.mitsuparts.com

or call

800-553-7278

SYSTEM RESET

If the TV does not respond to the remote control, control-panel buttons, or will not power on/off, press and hold the **POWER** button on the control panel for ten seconds.

The TV will turn off. Power on the TV and the green LED will flash quickly for about one minute. Recent setting changes may be lost.